

WATER RIGHT TRANSFER APPLICATION MAP

MAP 1 of 2 -- Revised 11/19/03
 Applicant: Ray Belnap
 4137 Kochemeier Road
 Vale, OR 97918
 541 473-2932

RECEIVED
 NOV 21 2003
 WATER RESOURCE DEPT.
 WA. EASTERN REGION

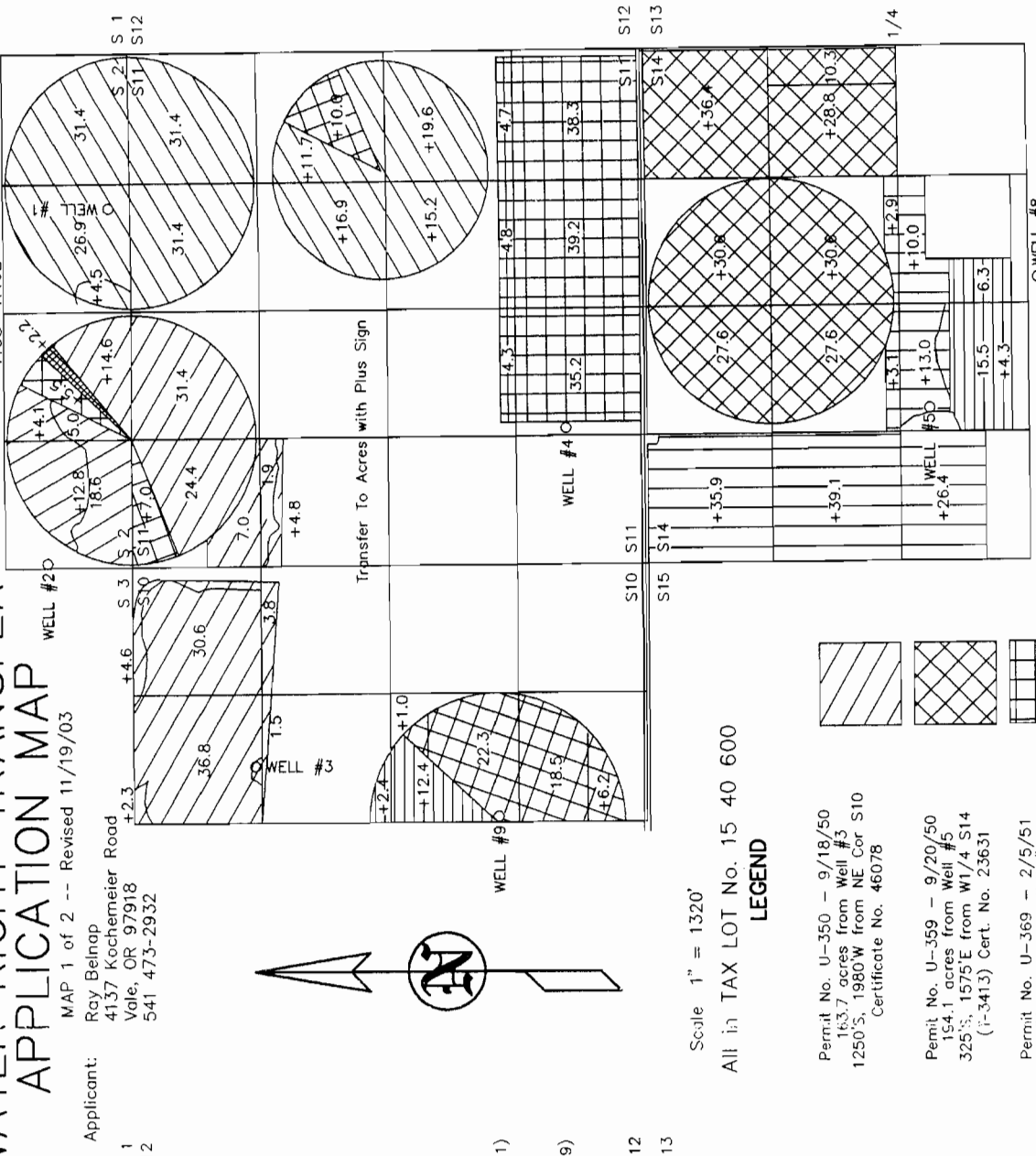

Scale 1" = 1320'
 All in TAX LOT No. 15 40 600
LEGEND

- Permit No. U-350 - 9/18/50
 163.7 acres from Well #3
 1250'S, 1980'W from NE Cor S10
 Certificate No. 46078
- Permit No. U-359 - 9/20/50
 154.1 acres from Well #5
 325'S, 1575'E from W1/4 S14
 (T-3413) Cert. No. 23631
- Permit No. U-369 - 2/5/51
 132 acres from Well #4
 730'N, 1400'E from SW cor S11
 Certificate No. 44207
- Permit No. U-391 - 5/10/51
 474.6 acres from Wells #6 & 7
 See Map 2 of 2
 Certificate No. 23632
- Permit No. U-392 - 5/10/51
 130.4 acres from Well #5
 Same as above
 (T-3413) Old Cert. No. 23633

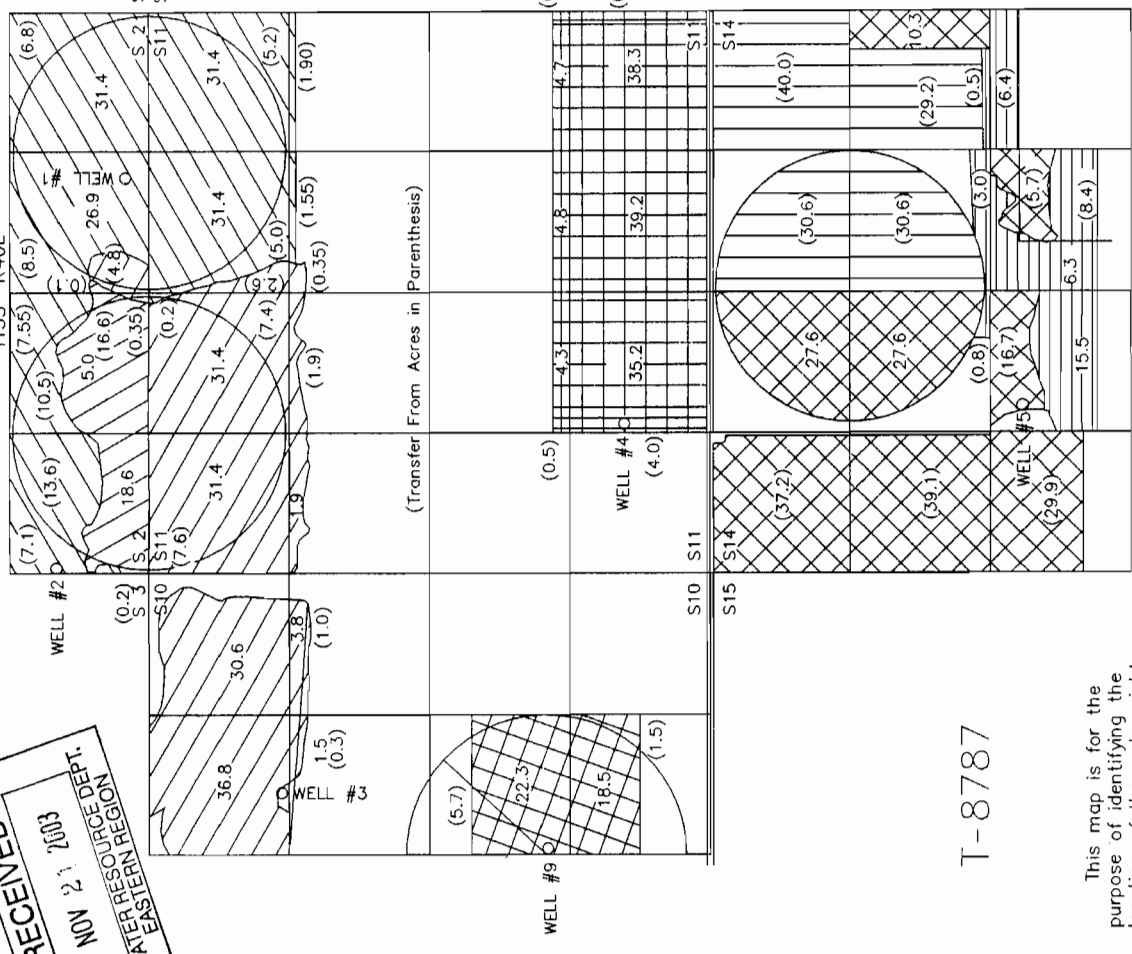

TRANSFER FROM MAP

- Permit No. U-320 - 2/14/50
 189.0 acres from Well #1
 225'N, 1560'W from SE Cor S2
 Certificate No. 44316
- Permit No. U-349 - 9/18/50
 40.5 acres from Well #2
 880'N, 55'E from SW Cor S2
 Certificate No. 23628

This map is for the purpose of identifying the location of the water right only and has no intent to provide dimensions or location of property ownership lines.

T-8787

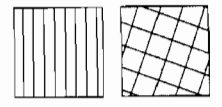
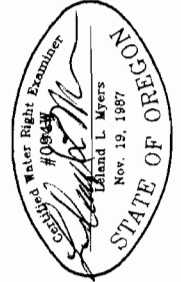

TRANSFER TO MAP

- Permit No. U-406 - 8/21/51
 40.9 acres from Well #8
 1420'S, 2370'W from E1/4 S14
 Certificate No. 23634
- Permit No. U-490 - 2/2/53
 48.0 acres from Well #9
 1460'N, 2600'W from SE Cor S10
 Certificate No. 44208

WATER RIGHT TRANSFER APPLICATION MAP

MAP 2 of 2 -- Revised 11/19/03

Applicant: Ray Beinap
4137 Koehneimer Road
Vale, OR 97918
541 473-2932

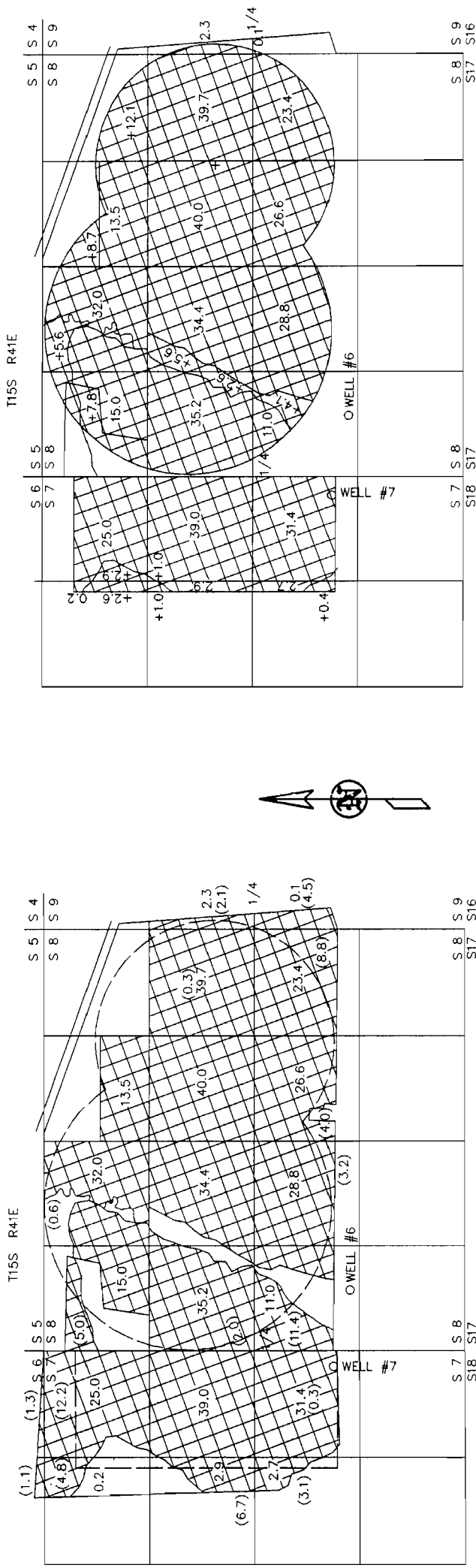
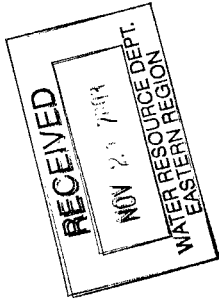

TRANSFER FROM MAP

(Transfer From Acres in Parenthesis)

Scale 1" = 1320'

TRANSFER TO MAP

Transfer To Acres with Plus Sign

Permit No. U-391 - 5/10/51
474.6 acres from Wells #6 & 7
Well #6
1200 S, 760E from W1/4 S8
and Well #7
995 S, 200W from E1/4 S7
Certificate No. 23632

This map is for the purpose of identifying the location of the water right only, and has no intent to provide dimensions or location of property ownership lines.

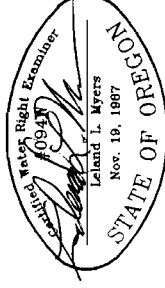

All in TAX LOT No. 15 41 300