

T4N R27E W.M.

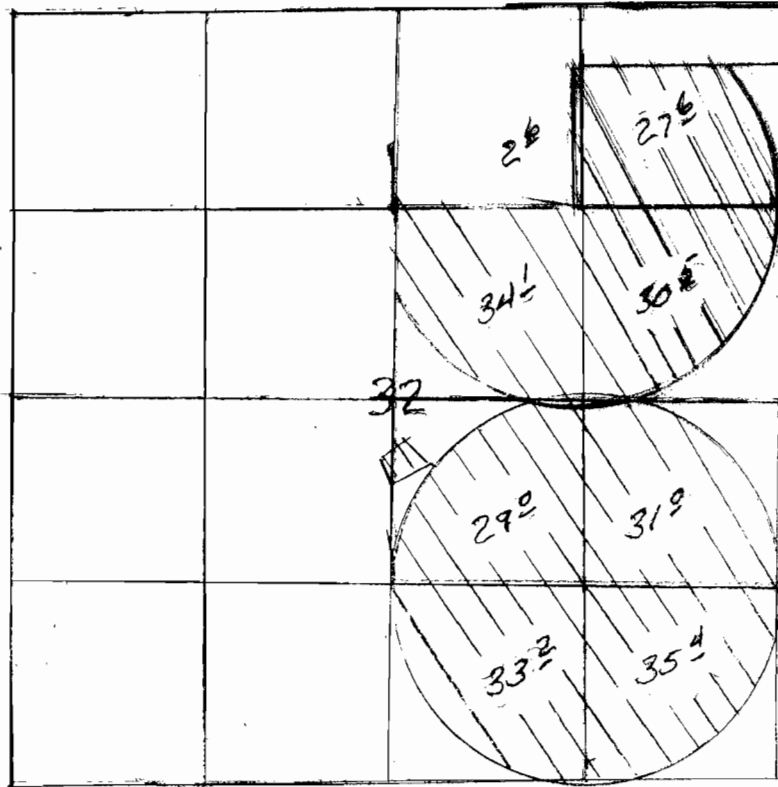

1" = 1320'

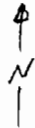

PARTIAL
FINAL PROOF SURVEY
UNDER

Application No. G-8649 Permit No. G-10836
IN NAME OF

CLWID

Surveyed APR 15-18 1995, by J. Miller

AMENDED 8/28/06 LHN
NAPP 1208-149R LHN

T4N R27E W.M.

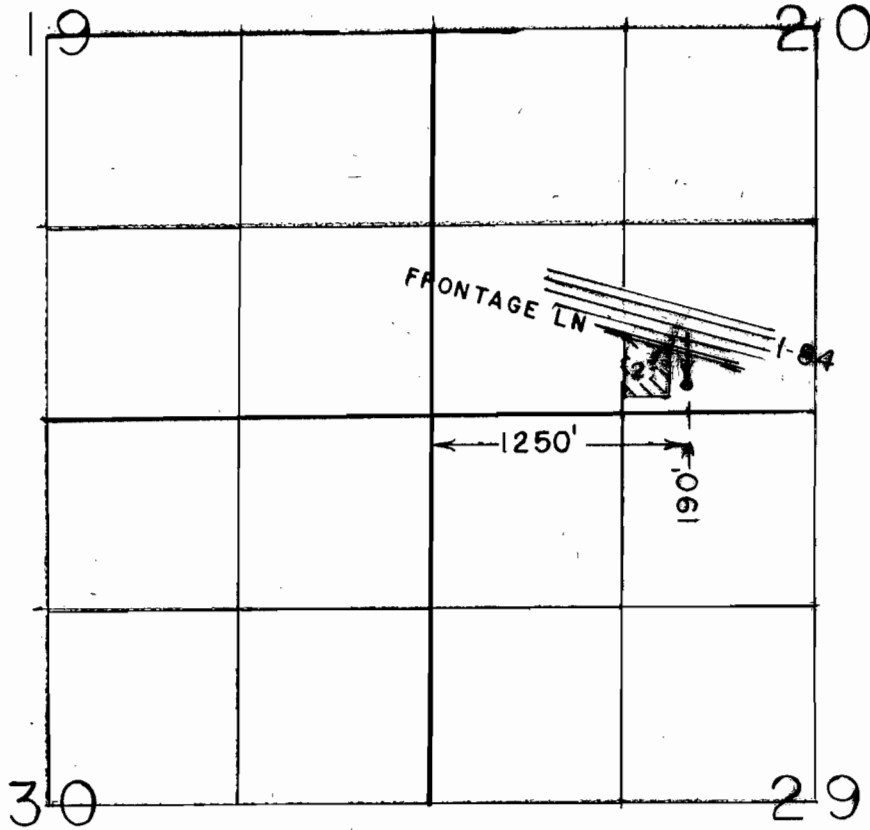

FINAL PROOF SURVEY
UNDER

TRANSFER 5737

Application No. Permit No.

IN NAME OF

..... THOMAS & PAMELA MANN

Surveyed AUG.... 1995., by J. MILLER.....

T. 4N., R. 27E. W. M.

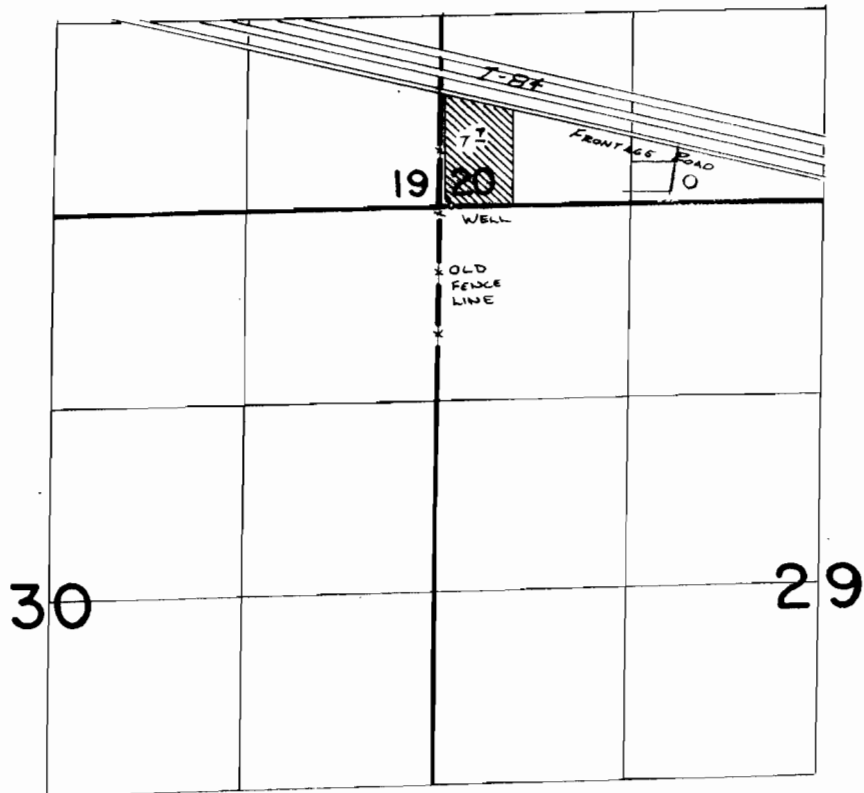

WELL LOC: 10' N. & 90° E. FROM SW COR. SEC 20

FINAL PROOF SURVEY
UNDER

Application No. **G:5590** Permit No. **G:4932**
IN NAME OF





.....**JOSE SOLANO**.....

Surveyed Feb. 14 1983, by V.L. Church

T4N, R27E, W.M.
MORROW COUNTY, OREGON
FINAL PROOF SURVEY

T-6097, T-6098, T-6099, T-6100, T-6101 and T-6102

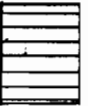
IN THE NAME OF
JEDEDIAH AYLETT
 Rt. 1, Box 1818
 Hermiston, Ore. 97838
 567-5938

-  T-6097
-  T-6098
-  T-6099
-  T-6100
-  T-6101
-  T-6102

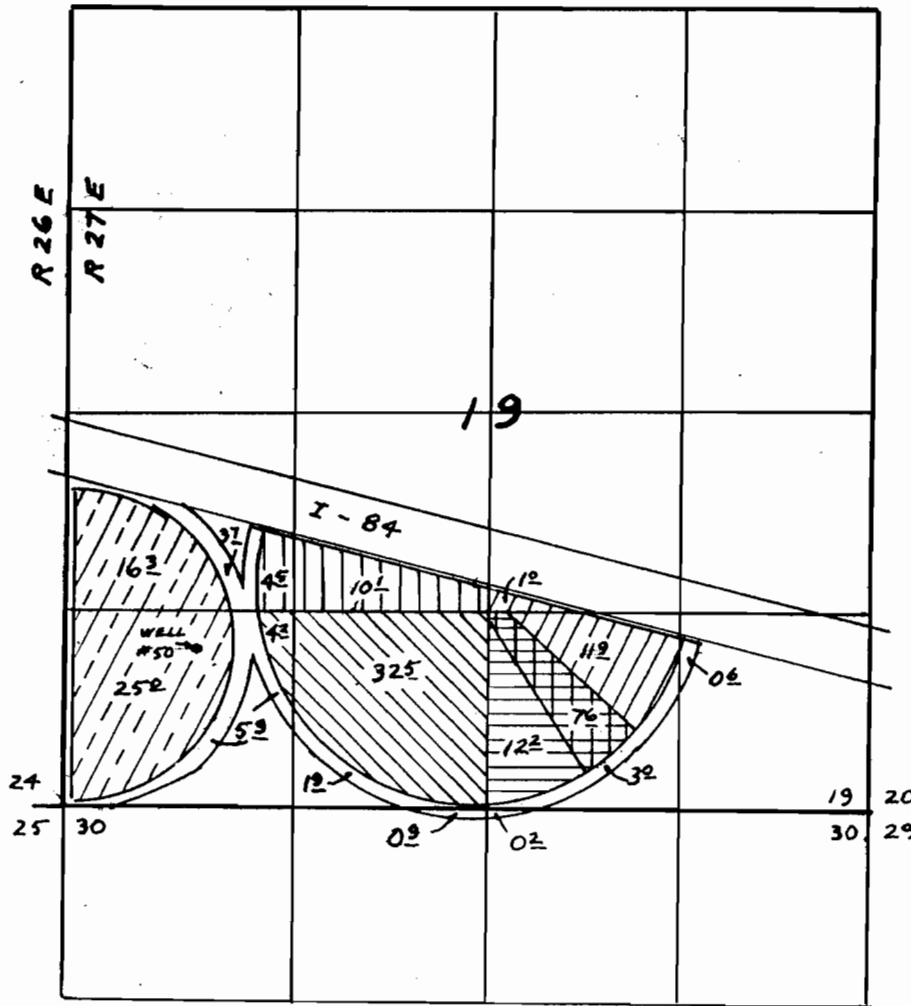

Scale: 1" = 1320'

Well # 50 lies 1077 feet N. and 910 feet E.
 of SW corner of Section 19.

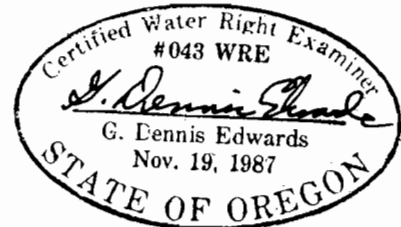

Edwards Surveying P.O. Box 763
 567-3336 Hermiston, OR. 97838
 10/1/91 Job # W8803009-A

This map is for identifying the location
 of water rights only and is not intended
 to show property lines or dimensions.

T7105



RECEIVED

MAR 04 1994

WATER RESOURCES DEPT.
SALEM, OREGON

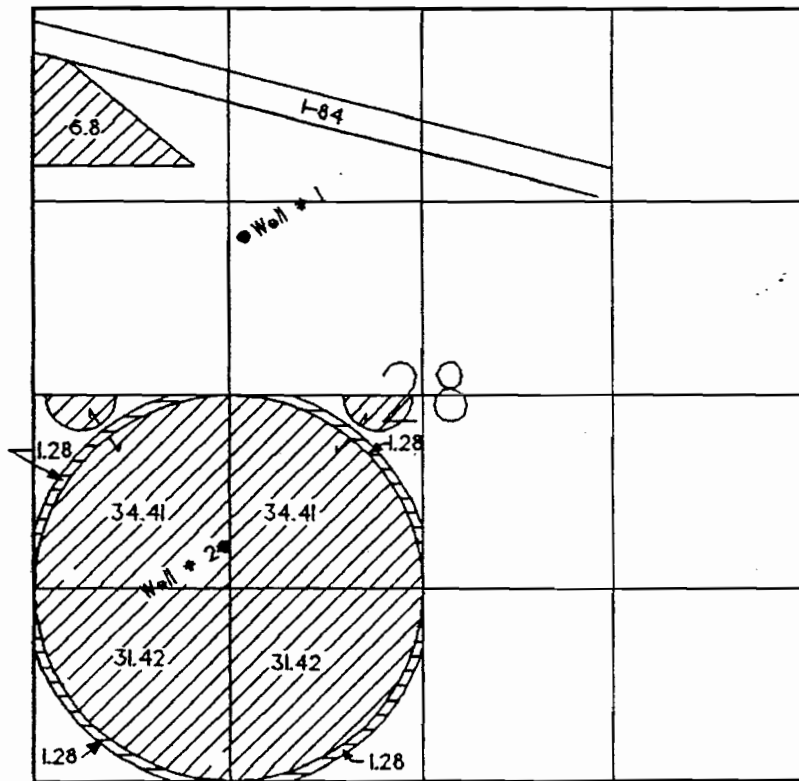
T 4 N. R 27 E. W. M.
MORROW COUNTY, OR
SCALE: 1" = 1320'



-  CERT. NO. 30019 TO STAY
-  CERT. NO 30019

This map is for identifying the location of water rights only and is not intended to show property lines or dimensions.

RECEIVED

APR 22 1988

T4N, R27E, W.M., MORROW COUNTY, OREGON WATER RESOURCES DEPT.
SALEM, OREGON

T-6099

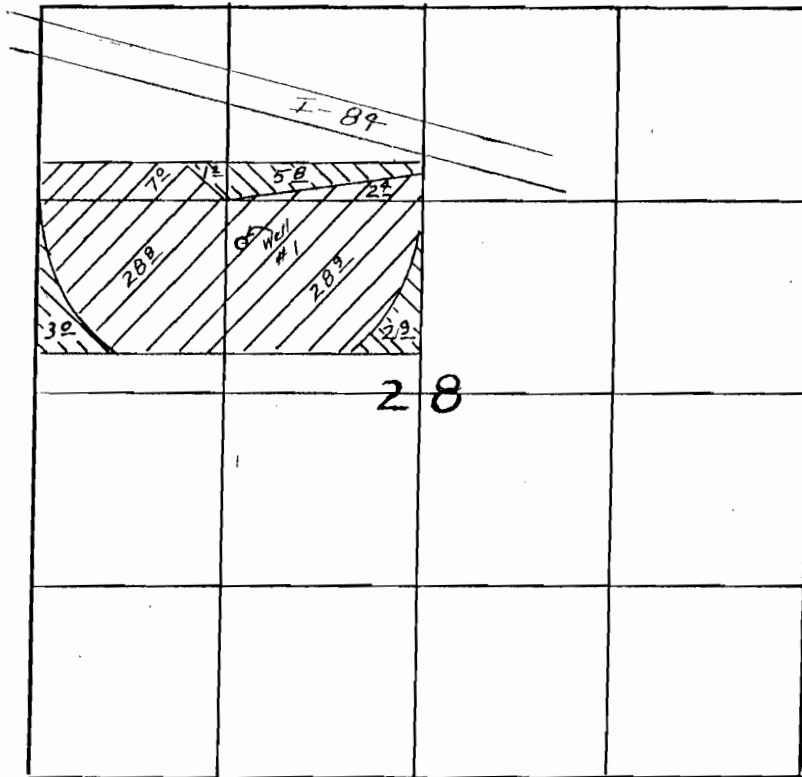

SCALE :
1" = 1320'



U 497
26073 To Stay



U 497
26073 To Transfer

source is Well #1 which lies
3700' N & 1420' E of SW Cor Sec 28

This map is for identifying
the location of water rights
only and is not intended to
show property lines or dimensions

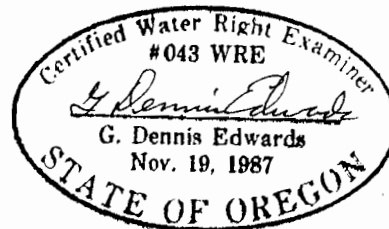

Application Map for Jedediah Aylett

4/15/88 Job # 8803009-B

Edwards Surveying P.O. Box 763

T-6102

T4N., R 27E, W.M., MORROW COUNTY, OR

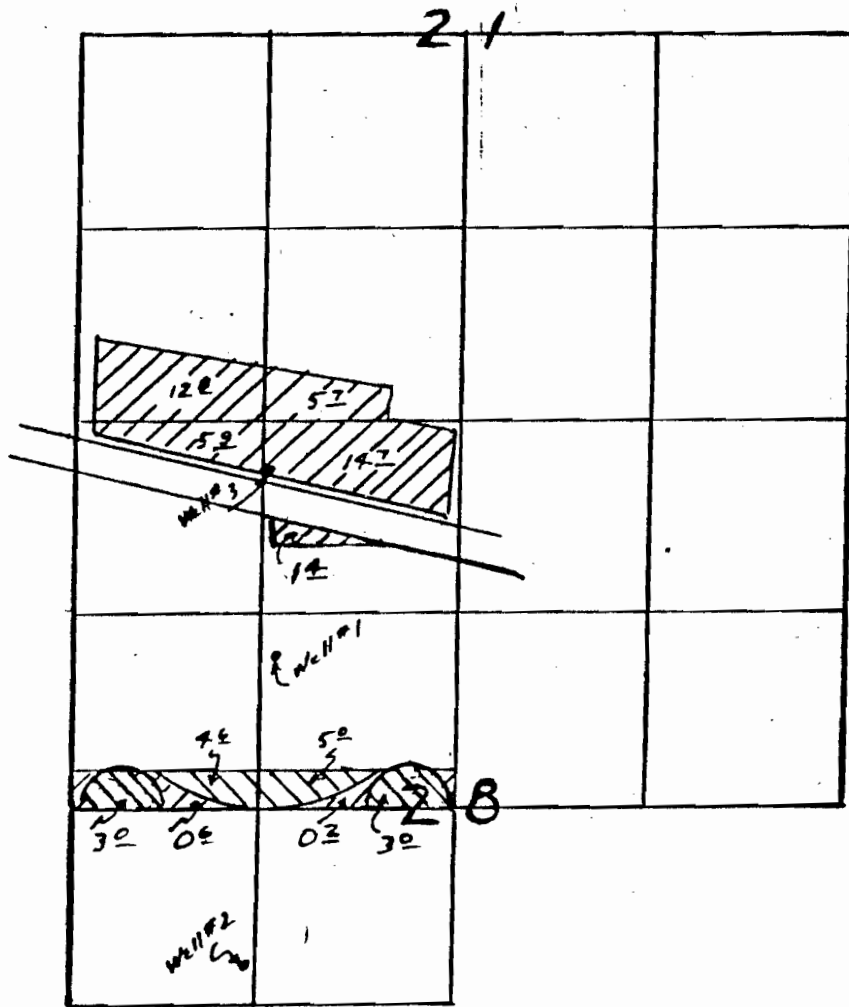

SCALE: 1" = 1320'



G 4929 To Stay



G 4929 To Transfer

Points of Diversion are

Well #1 56 Chains N & 21.5 Chains E of SW Cor. Sec. 28

Well #2 24.5 Chains N & 19.5 Chains E of SW Cor. Sec. 28

Well #3 IN NE 1/4 NW 1/4 Sec. 28

This map is for identifying the location of water rights only and is not intended to show property lines or dimensions

Application Map for Jedediah Aylett

4/15/89

Job # BB03009-E



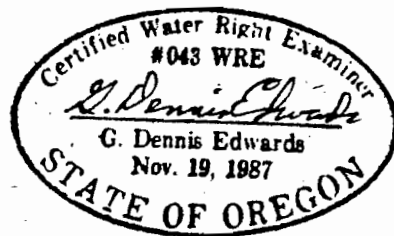

Rev. 7/9/88

Rev. 8/23/88

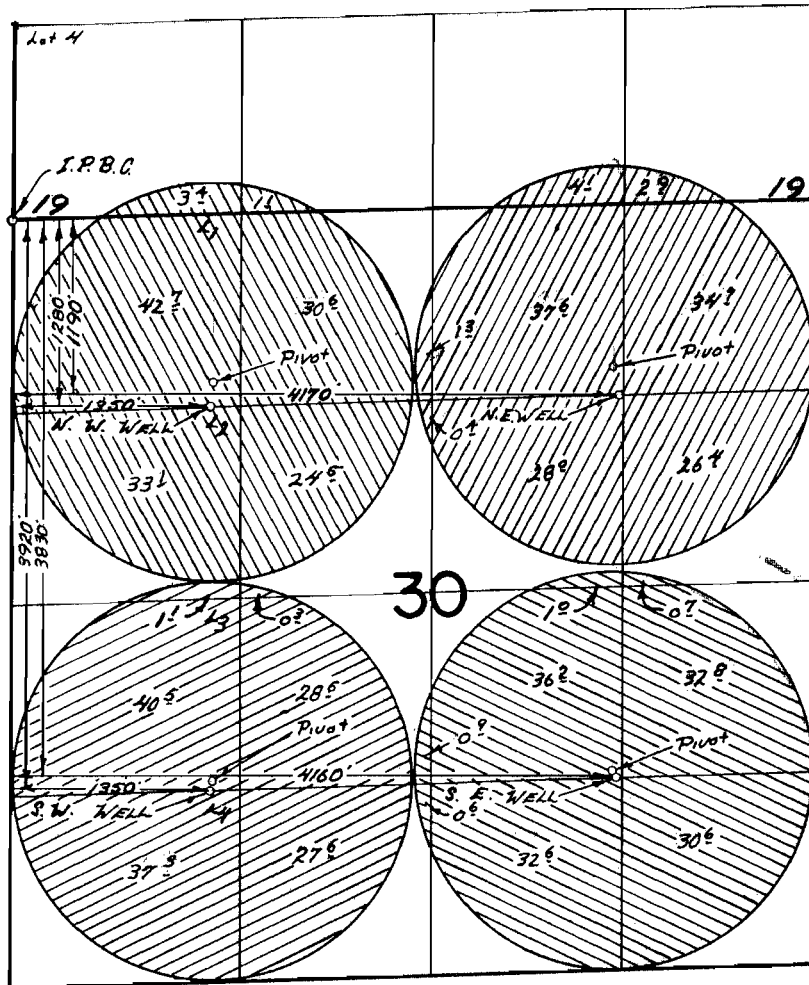

T.4N. R.27E. W.M.



-  NE WELL P.#2952
-  NW WELL P.#2952
-  SW WELL P.#2953
-  SE WELL P.#2953

FINAL PROOF SURVEY UNDER

Application No. 6-1011 Permit No. 6-2952
6-1012 6-2953
 IN NAME OF

JAMES A. WOOD/ALBERT STARR

Surveyed APRIL 10 1974, by D.M. NORBY

T.4N., R.27E., W.M.

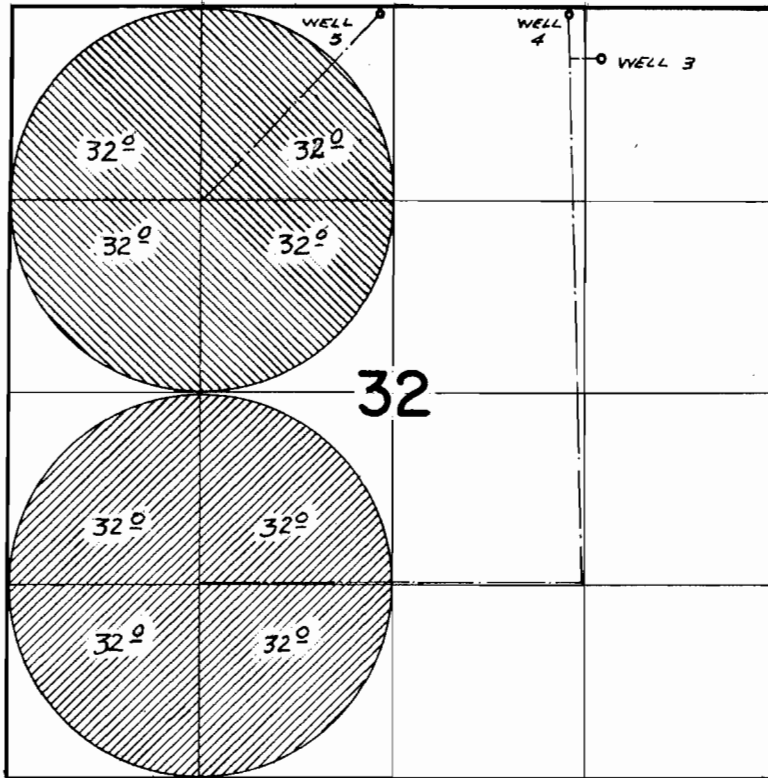

WELLS LOCATED: #3- 340'S & 1190' W; #4- 50'S & 1410' W; #5- 50'S & 2710' W
ALL FROM NE COR 32.

FINAL PROOF SURVEY UNDER

Application No. **G-3853** Permit No. **G-3629**
G-4140 **G-3889**
IN NAME OF



ESTATE OF ROY GAIL HOLZAPFEL

Surveyed April 10 1974, by David Forby

T.4N., R.27E., W.M.

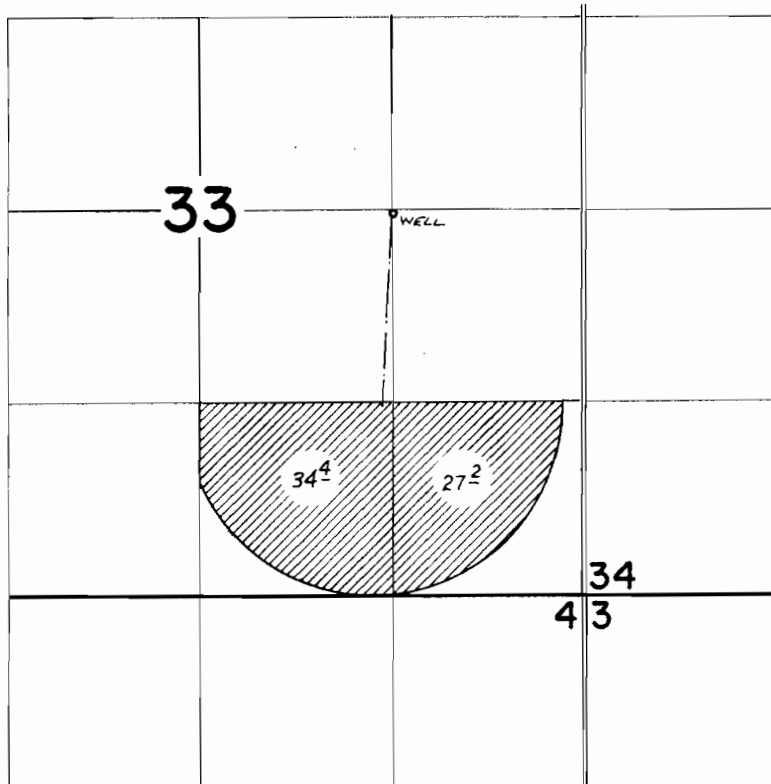

WELL LOC: 16'S & 1310' W FROM E $\frac{1}{4}$ COR. SEC 33.

FINAL PROOF SURVEY
UNDER

Application No. G-5112 Permit No. G-4821
IN NAME OF

JEDEDIAH WM. AND JUANITA AYLETT

Surveyed APR 11 1974, by R. Norby

T.3N.,R.27E.,W.M.

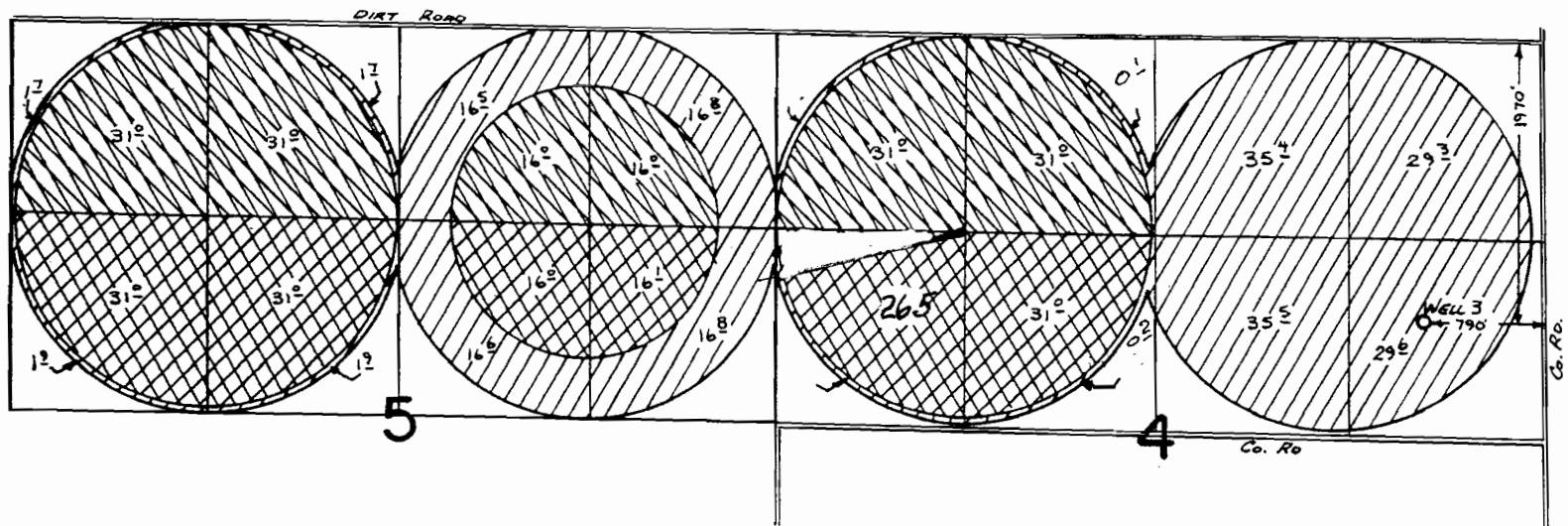

T.4N.,R.27E.,W.M.

30

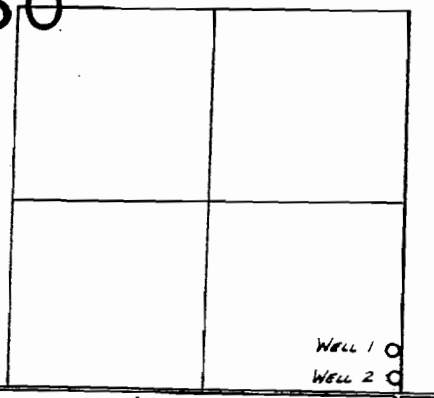

WELL 1 - 290° N and 50' W
 WELL 2 - 100° N and 40' W
 BOTH FROM SE COR. SEC. 30

SUPERSEDING
FINAL PROOF SURVEY
 UNDER

Transfer No. 3393

Application No. G-3092 Permit No. G-2823

G-5145 G-4878

IN NAME OF

JIM & DON KEY

Surveyed August 4, 1978 by R. BARWIN

April 11, 1975 by R. G. MUCKEN

MODIFIED FOR
 PERMIT G-10836
 4/5/06 LHM

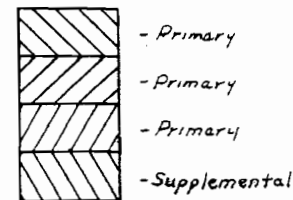

T 7105

RECEIVED

MAR 04 1994

WATER RESOURCES DEPT.
SALEM, OREGON

T 4 N. R 27 E. W. M.
MORROW COUNTY, OR
SCALE: 1" = 1320'

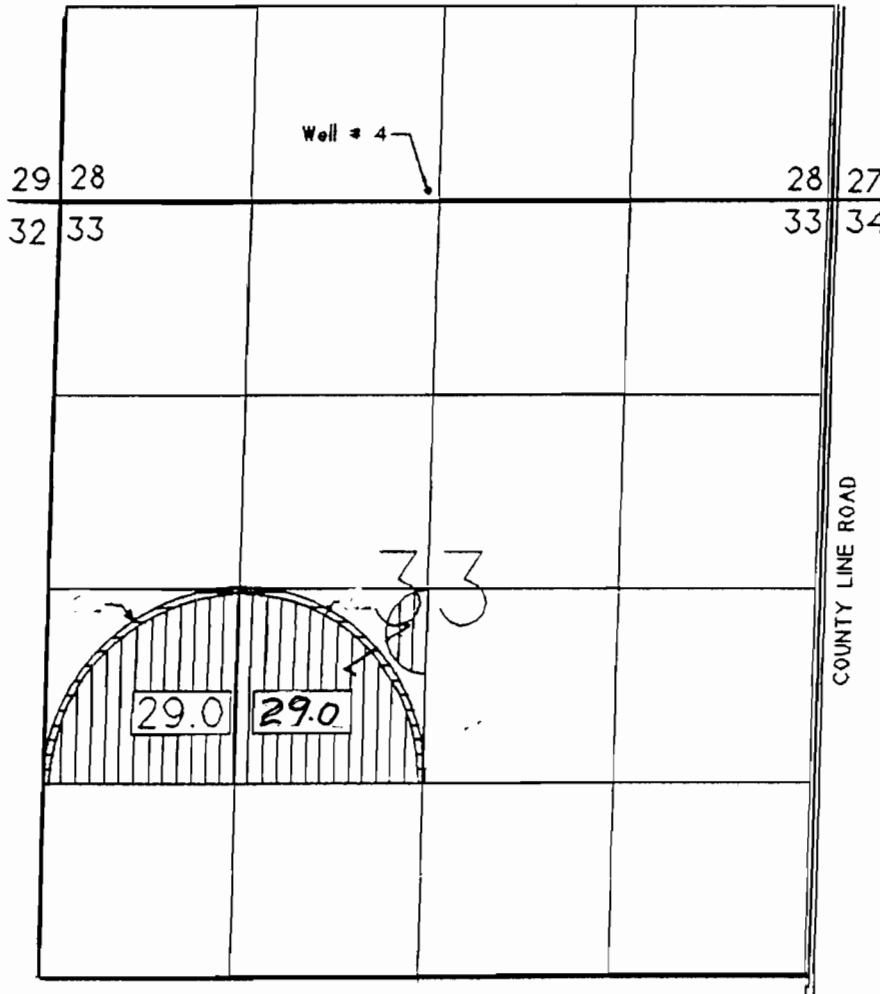

 CERT. NO. 49077
TO STAY

 CERT. NO 49077
TO TRANSFER

Well No. 4 lies 90' N. and
40' W. of the S 1/4 Cor.
of Section 28.

APPLICATION MAP FOR
JEDEDIAH AYLETT
RT. 1, BOX 1818 HERMISTON, OR
503 567 5938 97838

EDWARDS SURVEYING P. O. BOX 763
HERMISTON, OR. 97838 503 567 3336
2/1/94 JOB NO. W9402014

This map is for identifying the location of
water rights only and is not intended to
show property lines or dimensions.

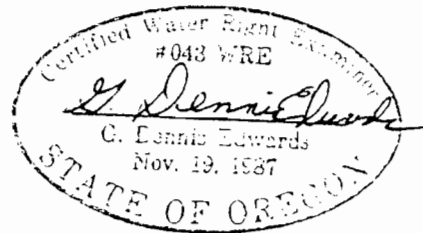

MODIFIED FOR
PERMIT 6-10836
4/5/06 LHN.

T 7105
RECEIVED

MAR 04 1994

WATER RESOURCES DEP.
SALEM, OREGON

T 4 N. R 27 E. W. M.
MORROW COUNTY, OR
SCALE: 1" = 1320'

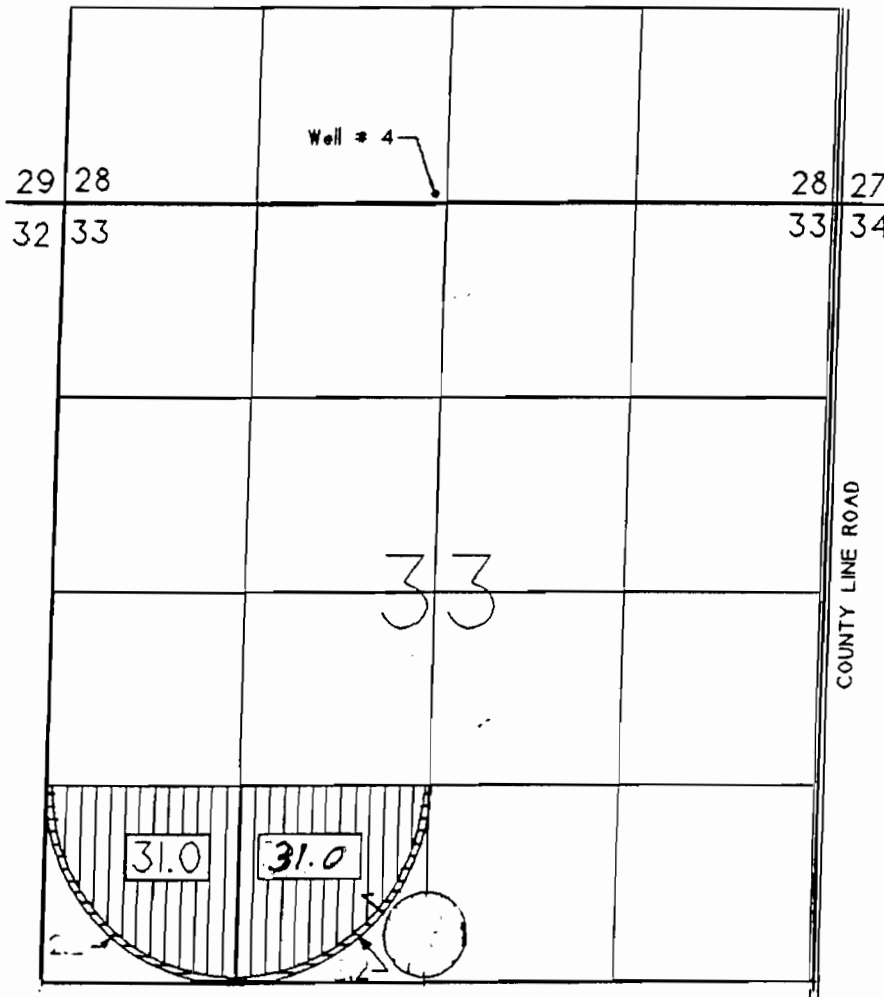

 CERT. NO. 49076
TO STAY

 CERT. NO. 49076
TO TRANSFER

Well No. 4 lies 90' N. and
40' W. of the S 1/4 Cor.
of Section 28.

APPLICATION MAP FOR
JEDEDIAH AYLETT
RT. 1, BOX 1818 HERMISTON, OR
503 567 5938 97838

EDWARDS SURVEYING P. O. BOX 763
HERMISTON, OR. 97838 503 567 3336
2/1/94 JOB NO. W9402014

This map is for identifying the location of
water rights only and is not intended to
show property lines or dimensions.

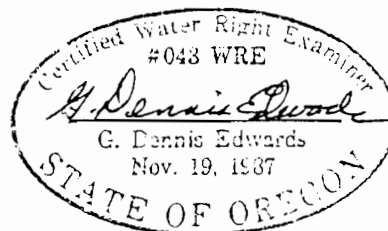

MODIFIED FOR
PERMIT G-10836
4/5/06 LAN

T-6100
RECEIVED

JUL 15 1988

WATER RESOURCES DEPT
SALEM, OREGON

T4N, R 27E, W.M., MORROW COUNTY, OR

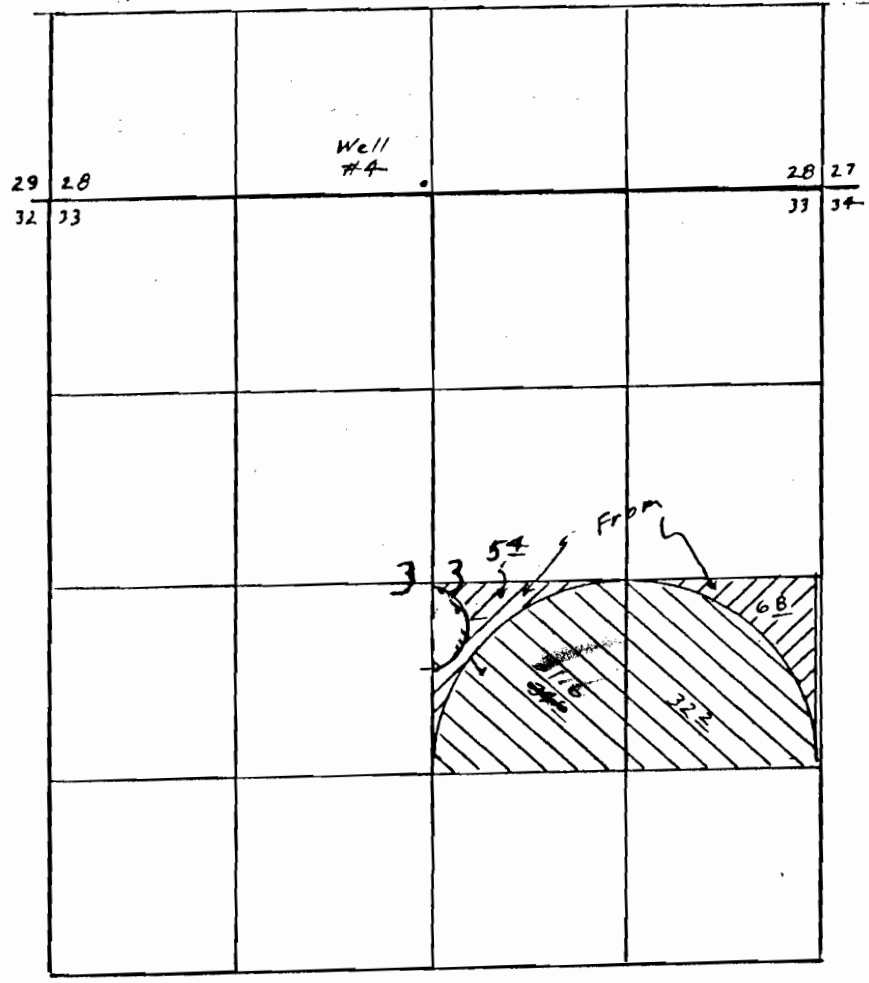

U-363 To Stay
#48549

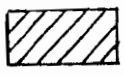

U-363 To Transfer
#48549

Source is well #4
90' N & 40' W 1/4 cor. Sec 28

This map is for identifying the location of water rights only and is not intended to show property lines or dimensions

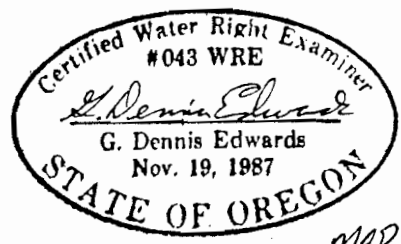

Application Map for Jedediah Aylett

7/15/88
7/9/88

Job # BB03009-C

MODIFIED FOR
PERMIT G-10836
4/5/06 LHN

T. 4 N., R. 27 E., W. M.

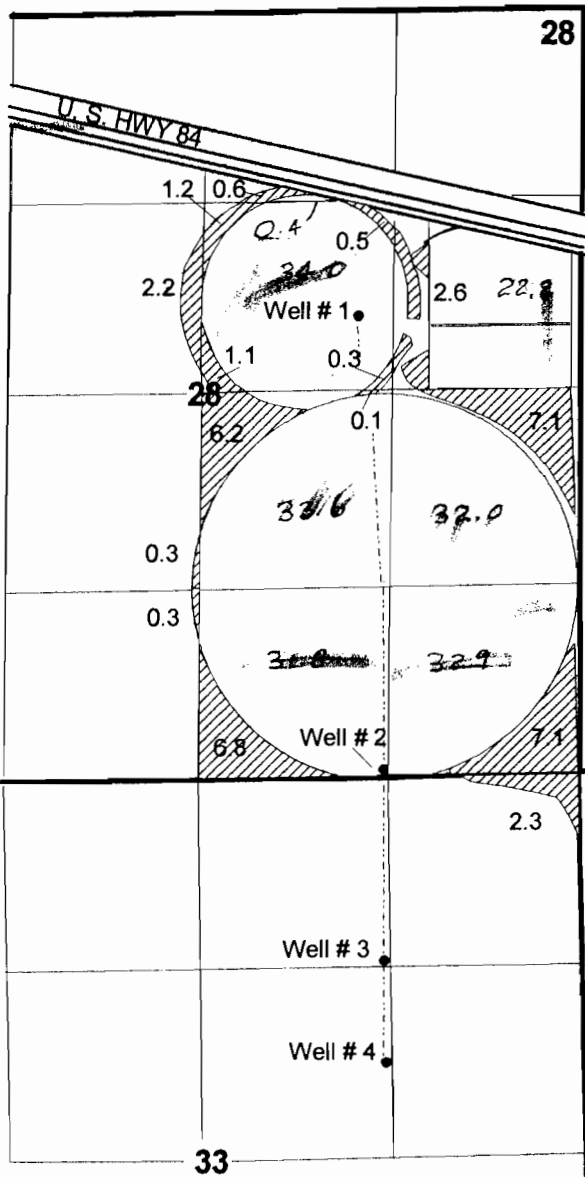

RECEIVED

DEC 02 2004

WATER RESOURCES DEPT
SALEM, OREGON

1" = 1320'

- WELL # 1 - 3180' N. & 1470' W. FROM SE COR. SECTION 28.
- WELL # 2 - 20' N. & 1350' W. FROM SE COR. SECTION 28.
- WELL # 3 - 1270' S. & 1350' W. FROM NE COR. SECTION 33.
- WELL # 4 - 1940' S. & 1350' W. FROM NE COR. SECTION 33.

FINAL PROOF SURVEY

UNDER

Application G-5026 Permit G-10504

IN THE NAME OF
12-H, INC.

Surveyed Aug. 15, 2003, By J. Miller

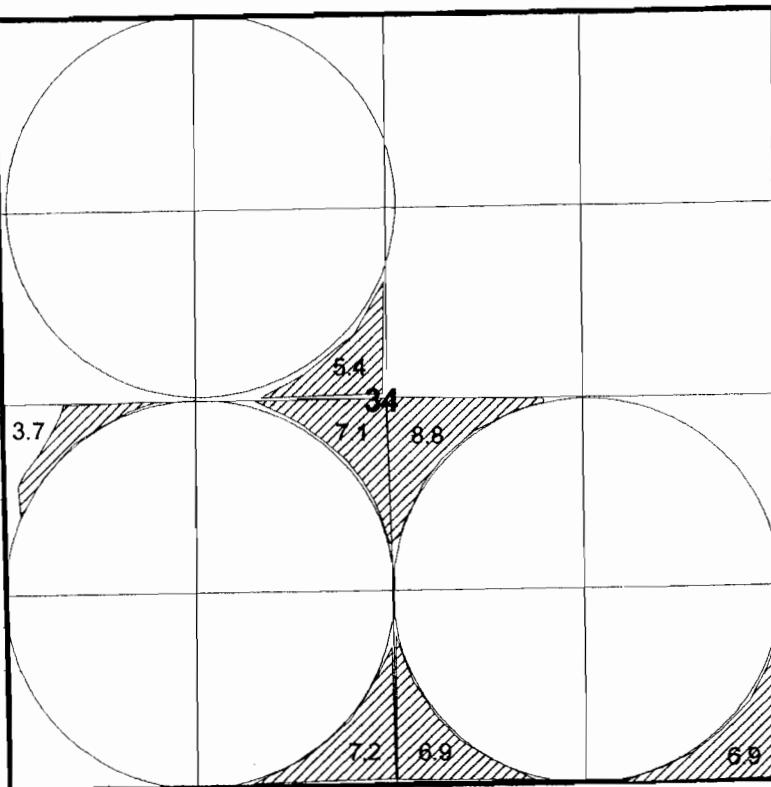

MODIFIED FOR
PERMIT G-10836
4/5/06 LHN

11/16/2004 JM

HANSELL BROTHERS INC.
ADDITIONAL POINT OF APPROPRIATION AMENDED
TRANSFER T-9275 APPLICATION MAP 2 of 4
WATER RIGHTS
 T. 4N., R.27E., W.M. UMATILLA COUNTY, OREGON

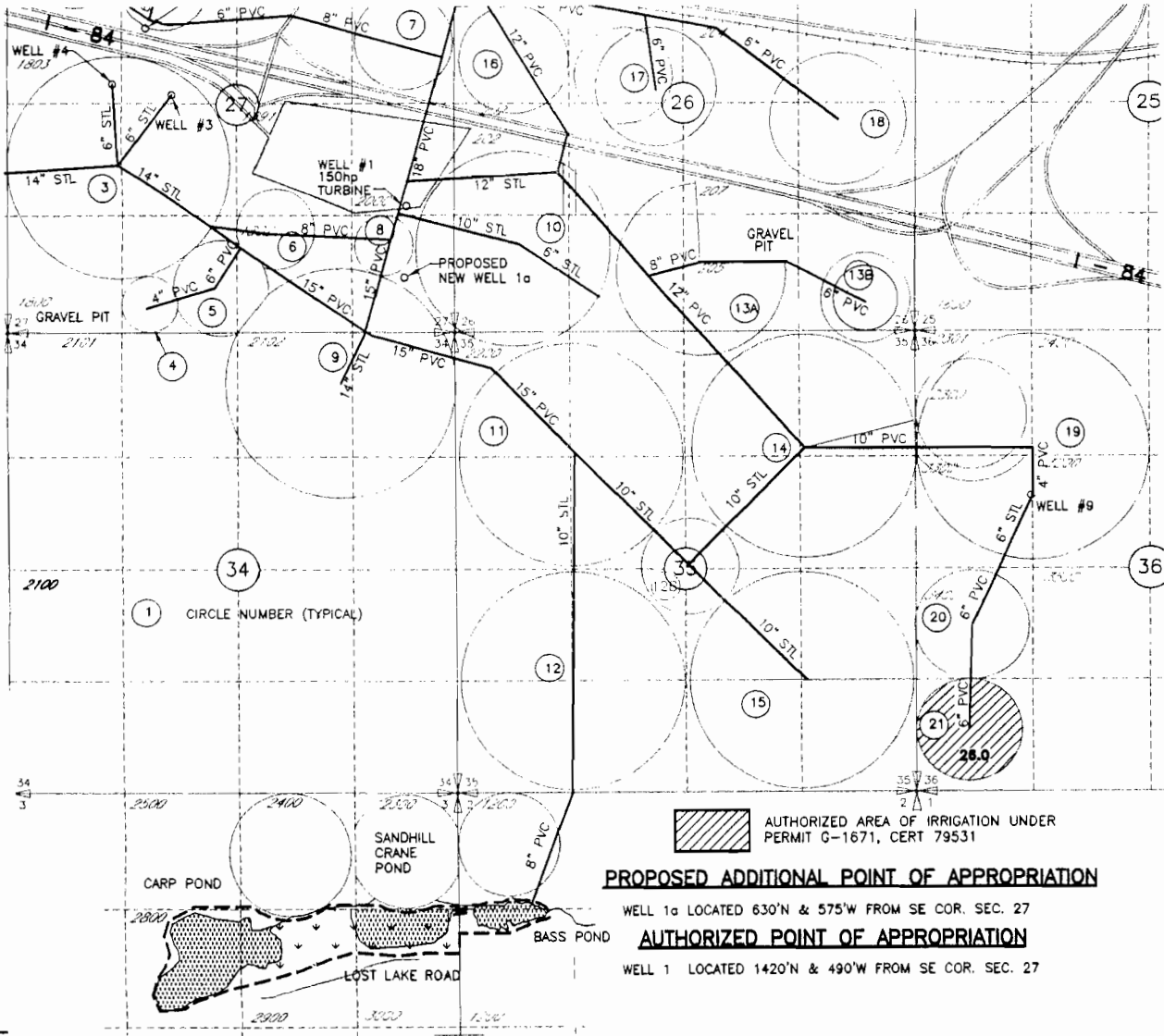

1 CIRCLE NUMBER (TYPICAL)

AUTHORIZED AREA OF IRRIGATION UNDER PERMIT G-1671, CERT 79531

PROPOSED ADDITIONAL POINT OF APPROPRIATION

WELL 1a LOCATED 630'N & 575'W FROM SE COR. SEC. 27

AUTHORIZED POINT OF APPROPRIATION

WELL 1 LOCATED 1420'N & 490'W FROM SE COR. SEC. 27

0 2640
 1 FEET





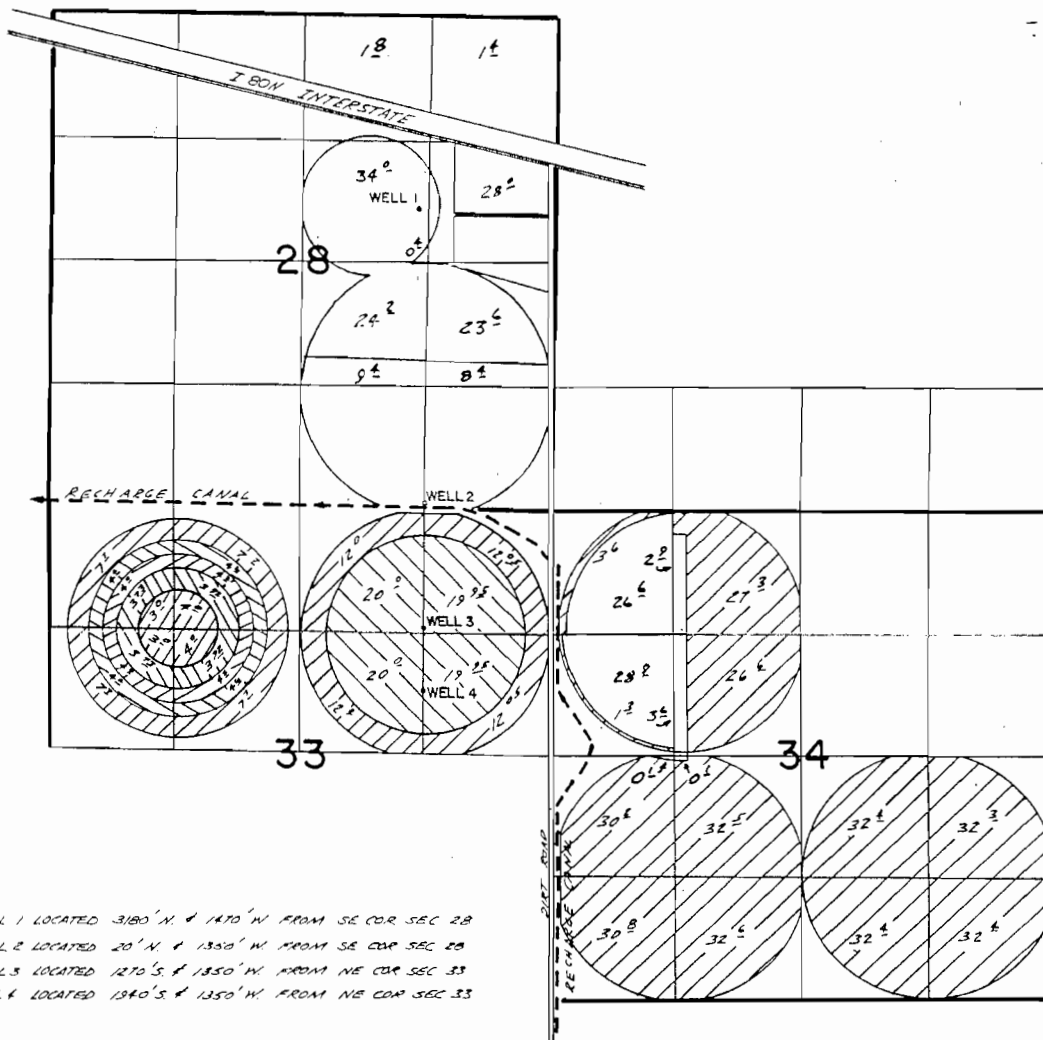

Certified Water Right Examiner
 #333 WRE
Dale G. VanSchoeck
 Dale G. VanSchoeck
 May 19, 1982
 State of Oregon

SCM Consultants
 A Tetra Tech
 DRAWING: H:\020\40\351
 PRINTED BY: roggers on 1

P IS TO IDENTIFY THE APPROXIMATE LOCATION IS NOT INTENDED TO PROVIDE INFORMATION I OF PROPERTY OWNERSHIP BOUNDARY LINES.



WELL 1 LOCATED 3180' N. & 1470' W. FROM SE COR. SEC. 28
 WELL 2 LOCATED 20' N. & 1350' W. FROM SE COR. SEC. 28
 WELL 3 LOCATED 1270' S. & 1350' W. FROM NE COR. SEC. 33
 WELL 4 LOCATED 1340' S. & 1350' W. FROM NB COR. SEC. 33

- | | | | |
|-------------------------------------------------------------------------------------|------------|-------------------------------------------------------------------------------------|--------|
|  | PER G-2822 |  | T-3902 |
|  | T-3903 |  | T-3904 |
|  | T-3905 |  | T-4089 |

FINAL PROOF SURVEY
 UNDER

APPL. G-2831 PER. G-2822
 TRANSFERS

3902 3903 3904
 3905 4089

IN NAME OF
I2H, INC.

SURVEYED 8-2 1978, BY R. BARWIN

V.L.C.

HANSELL BROTHERS INC. FINAL PROOF
 AMENDED DECEMBER 11, 1996 and 2-4-97

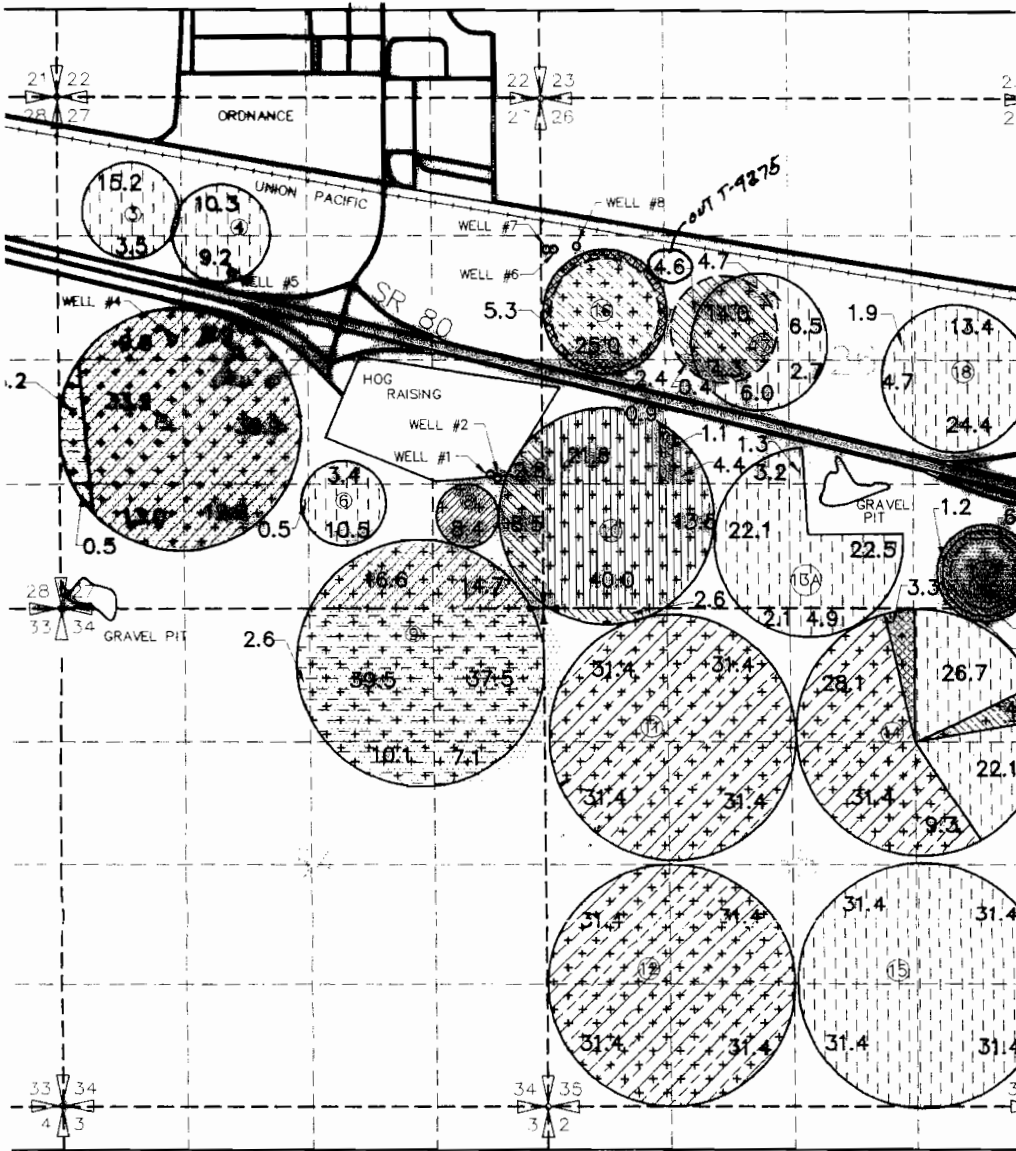

- LL 1 LOCATED 1420'N & 490'W FROM SE COR. SEC.27 BEING WITHIN NE 1/4 SE 1/4
- LL 2 LOCATED 1390'N & 430'W FROM SE COR. SEC.27 BEING WITHIN NE 1/4 SE 1/4
- LL 3 LOCATED 2740'N & 1890'E FROM SW COR. SEC.27 BEING WITHIN SE 1/4 NW 1/4
- LL 4 LOCATED 230'N & 1210'E FROM W 1/4 COR. SEC.27 BEING WITHIN SW 1/4 NW 1/4
- WELL 5 LOCATED 960'N & 1850'E FROM W 1/4
- WELL 6,7 LOCATED 1130'N & 60'E FROM W 1/4 Ct
- WELL 8 LOCATED 1160'N & 370'E FROM W 1/4 C
- WELL 9 LOCATED 1884'S & 1315'E FROM NW Ct

	T-4152		PERMIT NO. G-2694		CIRCLE NUMBER
	PERMIT NO. U-649		T-4928	31.4	IRRIGATED ACREAGE
	PERMIT NO. G-3822 SUPPLEMENTAL & T-4929		PERMIT NO. G-2335		
	G-3822 PRIMARY		T-4926		