

T.17&18S.R.46E.W.M.

- PRIMARY IRRIGATION - MALHEUR RIVER
 - PERMIT No. 30621
 - PERMIT No. 33946
- PRIMARY IRRIGATION - SNAKE RIVER
 - PERMIT No. 31231
 - PERMIT No. 33944
- SUPPLEMENTAL IRRIGATION - SNAKE RIVER
 - PERMIT No. 33945

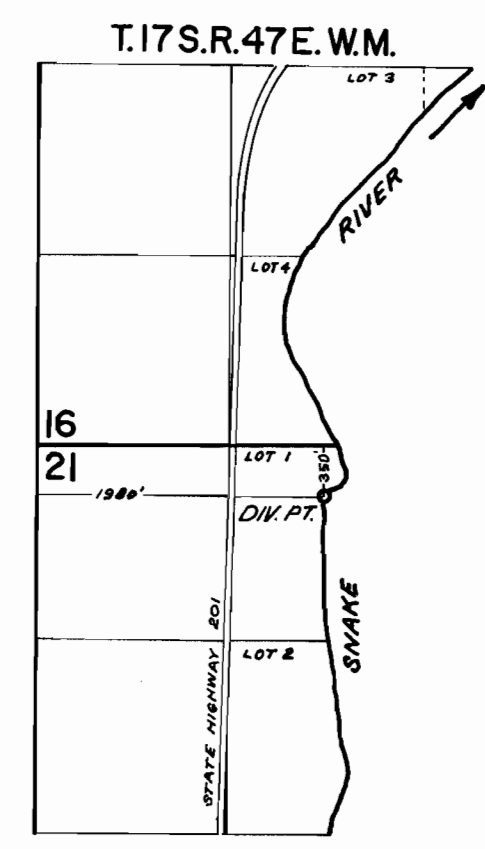
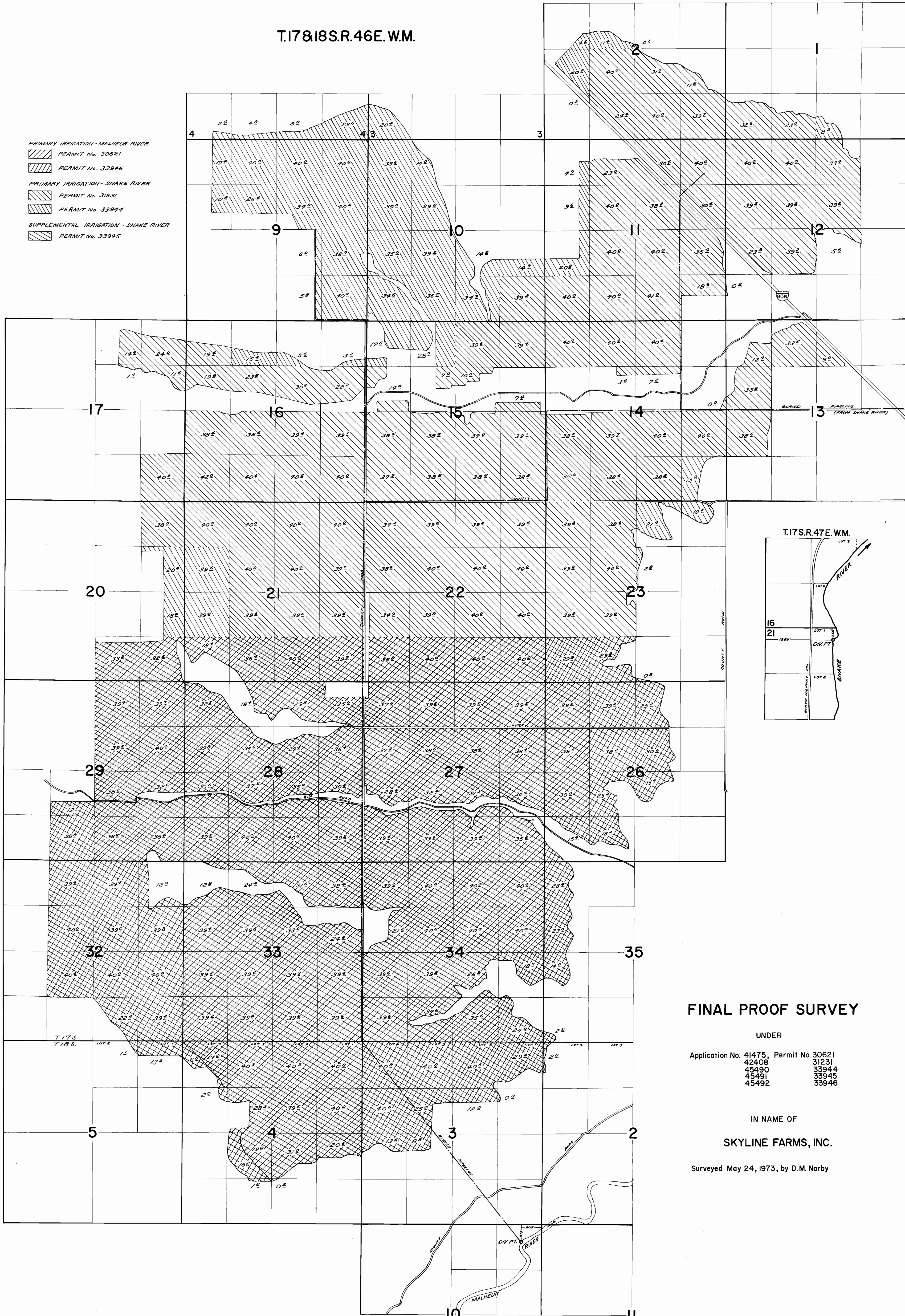

FINAL PROOF SURVEY

UNDER

Application No. 41475, Permit No. 30621
 42408 31231
 45490 33944
 45491 33945
 45492 33946

IN NAME OF

SKYLINE FARMS, INC.

Surveyed May 24, 1973, by D.M. Norby

T. 17 S., R. 46 E. W.M.

RECEIVED
DEC 24 2007
WATER RESOURCES DEPT
SALEM OREGON

1320 0 1320 2640
SCALE: 1 INCH=1320 FEET

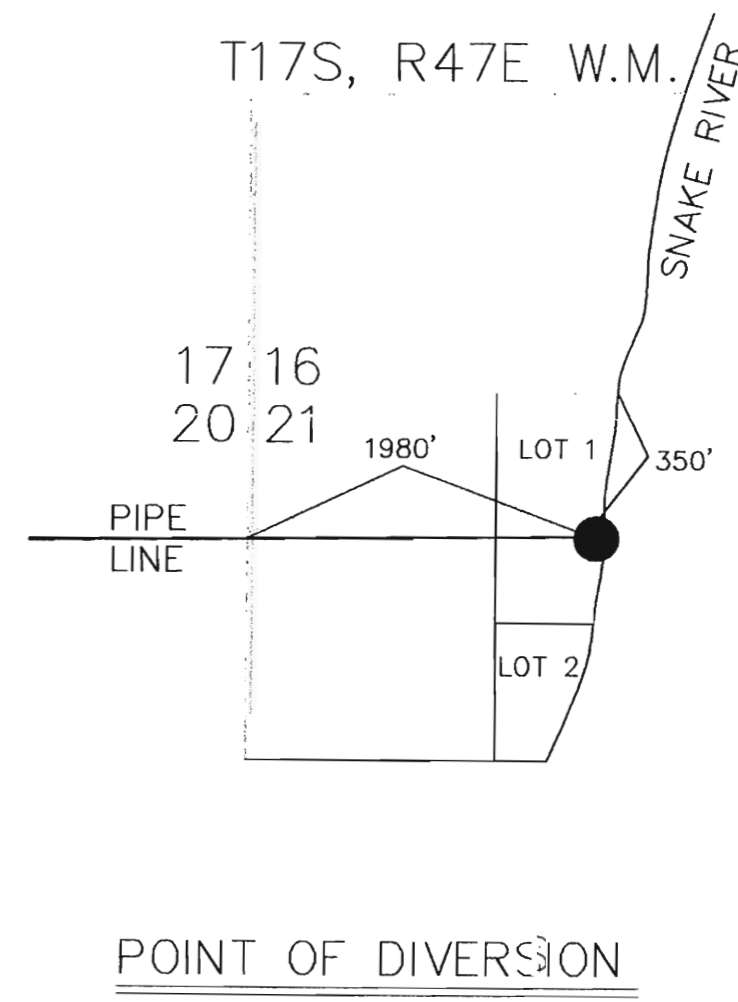
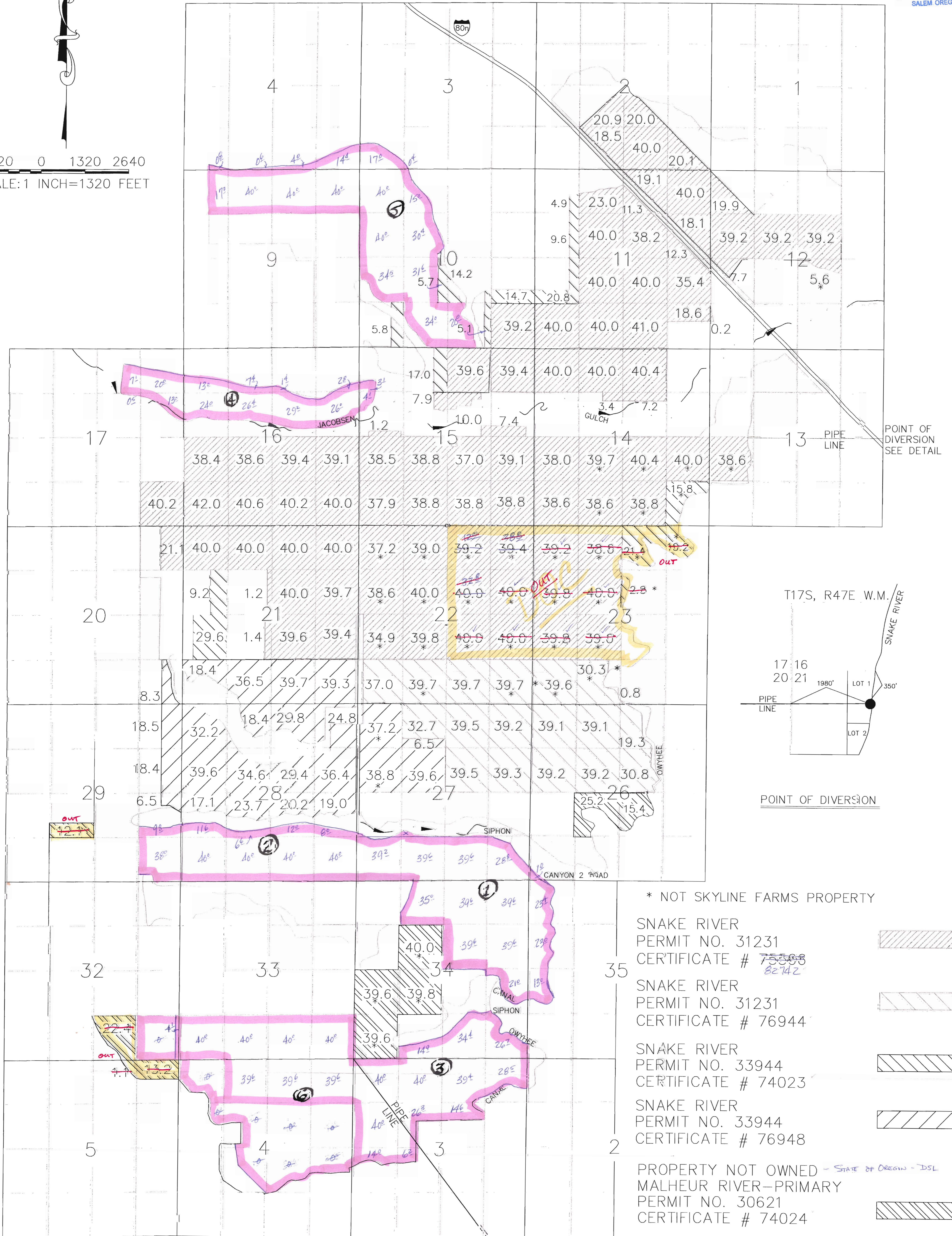

- * NOT SKYLINE FARMS PROPERTY
- SNAKE RIVER
 PERMIT NO. 31231
 CERTIFICATE # 75508
 82742
- SNAKE RIVER
 PERMIT NO. 31231
 CERTIFICATE # 76944
- SNAKE RIVER
 PERMIT NO. 33944
 CERTIFICATE # 74023
- SNAKE RIVER
 PERMIT NO. 33944
 CERTIFICATE # 76948
- PROPERTY NOT OWNED - STATE OF OREGON - DSL
 MALHEUR RIVER-PRIMARY
 PERMIT NO. 30621
 CERTIFICATE # 74024
- SNAKE RIVER-SUPPLEMENTAL
 PERMIT NO. 33945
 CERTIFICATE # 74022
- MALHEUR RIVER-PRIMARY
 PERMIT NO. 33946
 CERTIFICATE # 74021

SKYLINE FARMS WATER RIGHTS
 APPLICATION FOR ALLOCATION OF CONSERVED WATER

THIS MAP IS FOR THE PURPOSE OF IDENTIFYING THE LOCATION OF WATER RIGHTS ONLY AND IS NOT INTENDED TO PROVIDE LEGAL DIMENSIONS OR LOCATION OF PROPERTY LINES.

WATER RIGHTS DATA TAKEN FROM PERMIT AND FINAL PROOF SURVEY BY D.M. NORBY 5/24/73 WERE USED TO HELP DEVELOPE THIS MAP

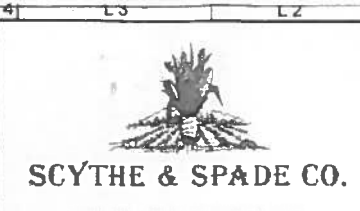

RECEIVED
OCT 06 2015
WATER RESOURCES DEPT
SALEM, OREGON

PAGE 1

CERTIFIED WATER RIGHTS EXAMINER
69277
John M. Rehm
Dec. 31, 2010
STATE OF OREGON

Status- For Certificate 84867

1 in = 1,320 ft

FROM (diagonal hatching)

TO (cross-hatching)

Skyline Farm Boundary (thick solid line)

Township/Range (dashed line)

Section (dotted line)

quarter-quarter-sections (thin solid line)

Although the information contained herein is considered to be accurate, Scythe & Spade is making no representation or warranty to that affect, either express or implied. The information contained herein is subject to verification and no liability for errors and omissions is assumed. All acreages, dimensions, measurements, computations, and locations are approximate. This map is NOT a survey and is intended for reference use only.

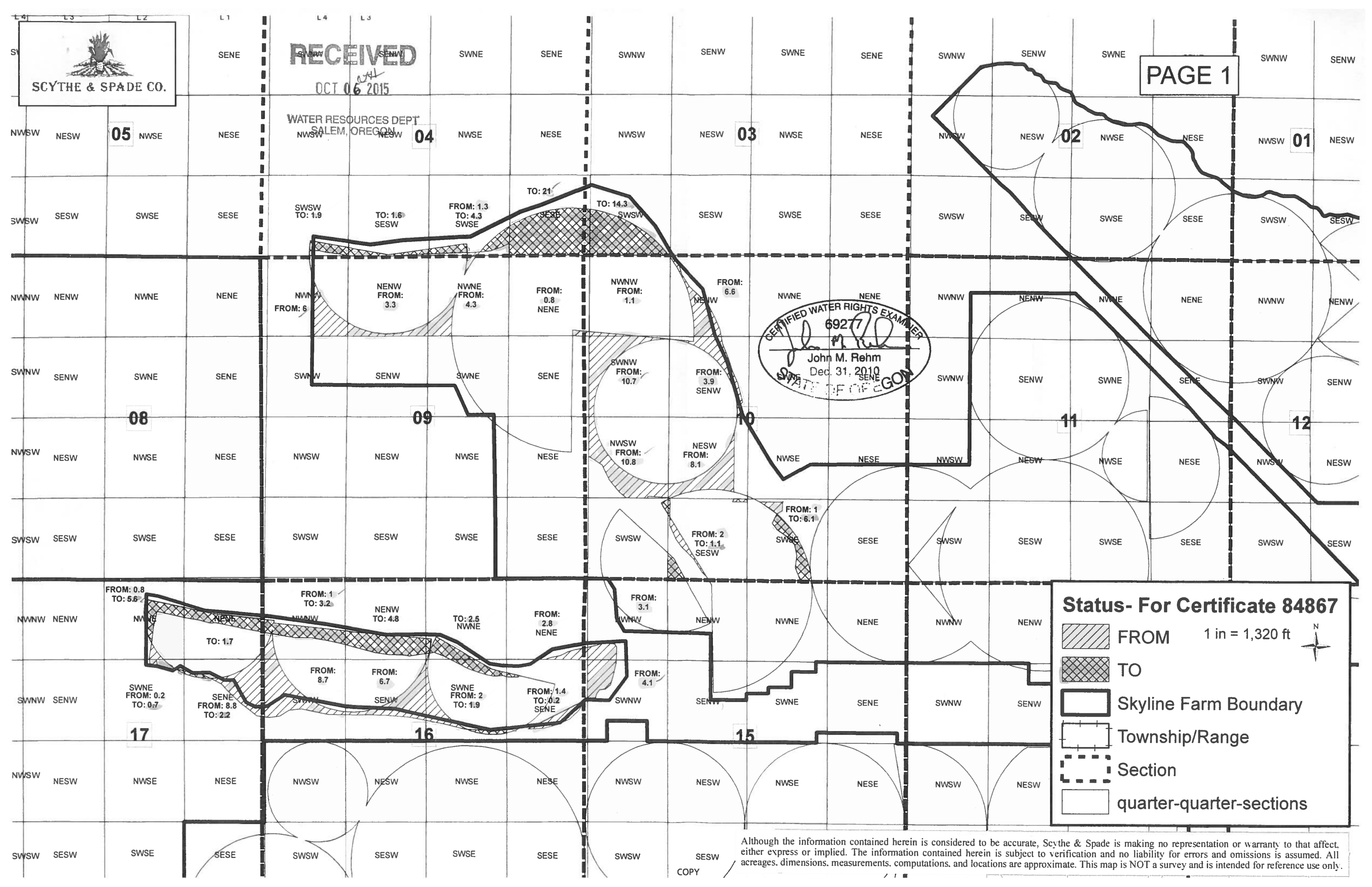

COPY

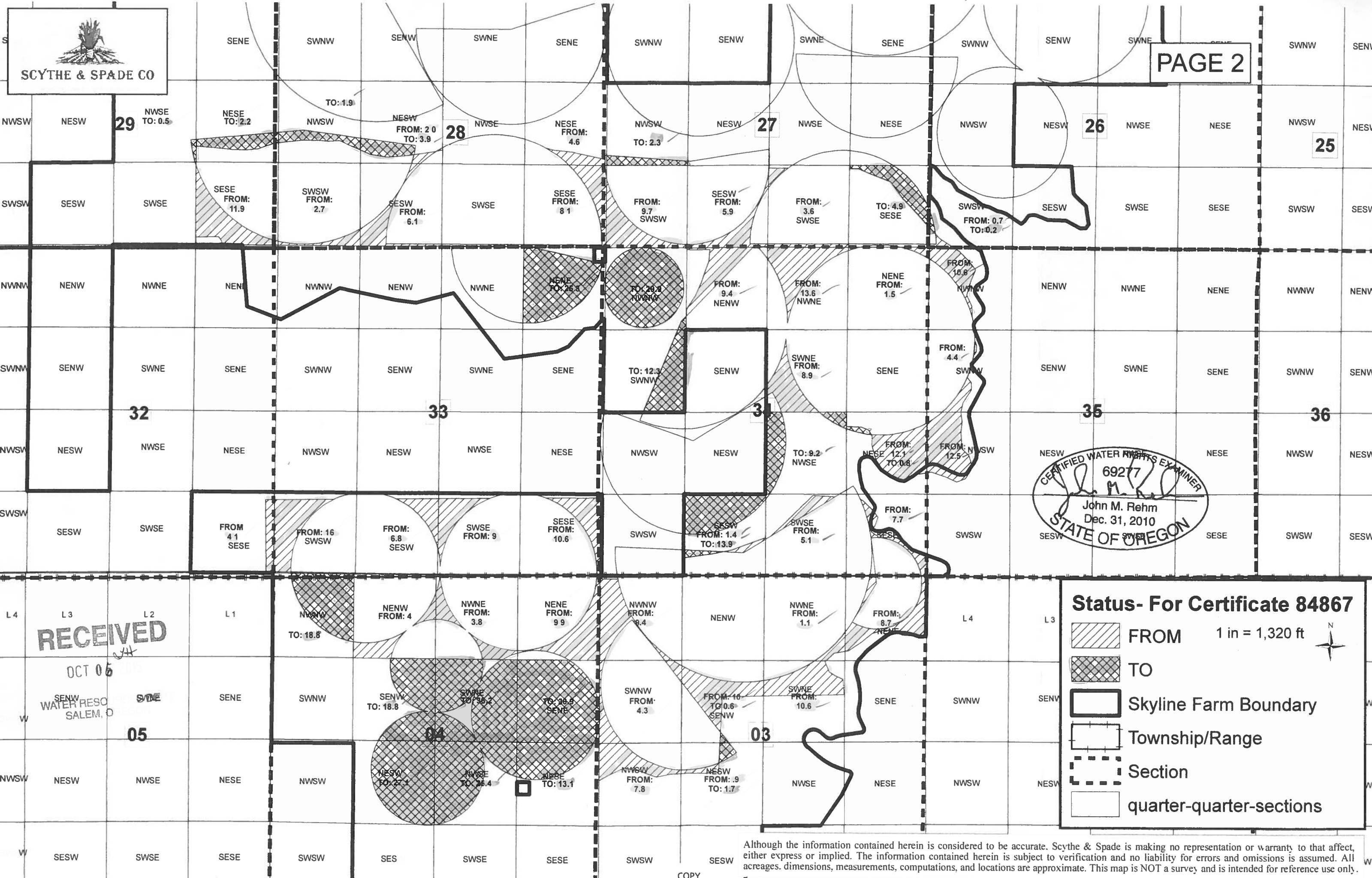
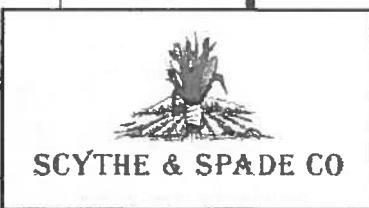

CERTIFIED WATER RIGHTS EXAMINER
69277
John M. Rehm
Dec. 31, 2010
STATE OF OREGON

RECEIVED

OCT 06

SEW WATER RESO SALEM, O

05

Status- For Certificate 84867

- FROM 1 in = 1,320 ft
- TO
- Skyline Farm Boundary
- Township/Range
- Section
- quarter-quarter-sections

Although the information contained herein is considered to be accurate. Scythe & Spade is making no representation or warranty to that affect, either express or implied. The information contained herein is subject to verification and no liability for errors and omissions is assumed. All acreages, dimensions, measurements, computations, and locations are approximate. This map is NOT a survey and is intended for reference use only.