

# Application Map Water Rights Transfer "Off" Map

RECEIVED

APR 20 2018

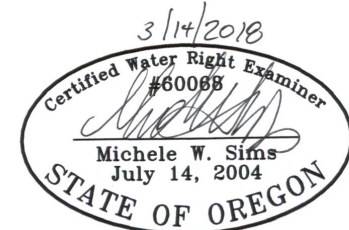
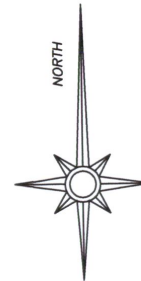
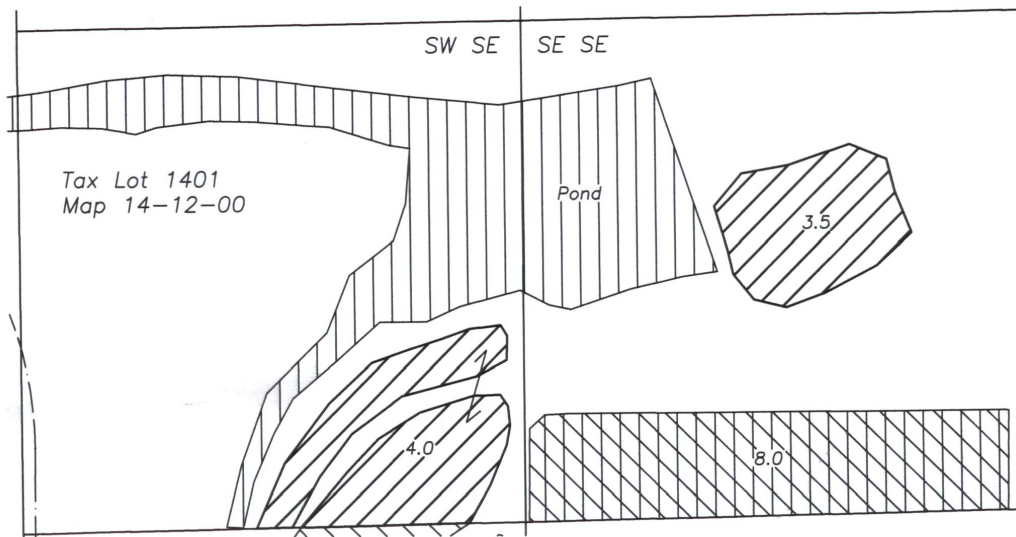

OWRD

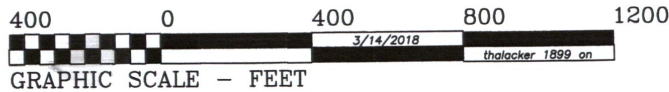

Renewal date: 6/30/2018

Section 7  
T14S R12E  
Deschutes Co. OR



-  Supplemental water to transfer off (Cert. 74139, priority 10/18/1979)
-  Supplemental water remaining (Certificate 74139)
-  Primary water remaining (Certificate 74136 1895)

This map is for the purpose of identifying the location of the water right. It is not intended to provide legal dimensions or locations of property ownership lines.

Sheet 1 of 4

T. 14 S., R. 12 E., Wm.

1" = 400'



Sections 7 + 18

Final proof map for <sup>of</sup> 85.5 acres  
Supplemental irrigation and pond  
maintenance under permit G-8683.  
Use under this permit was confirmed  
at the approval of Snow Creek Irrigation  
District's Remapping Petition  
Bob Main (OWRD)  
March 5, 1997

1401

Sec. 7  
SE 1/4 SE 1/4

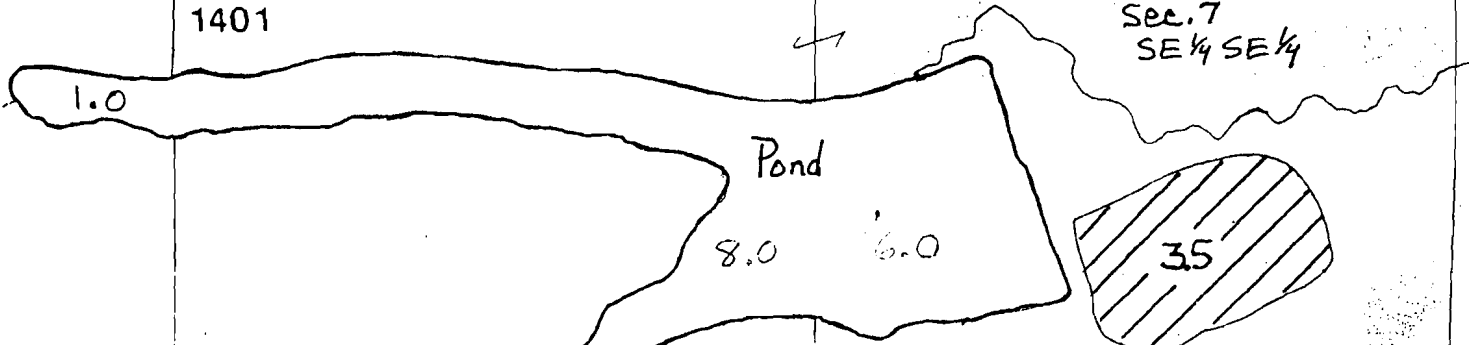

Pond

1.0

8.0

6.0

35

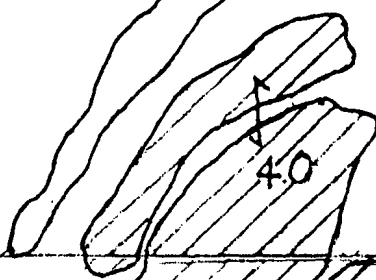

4.0

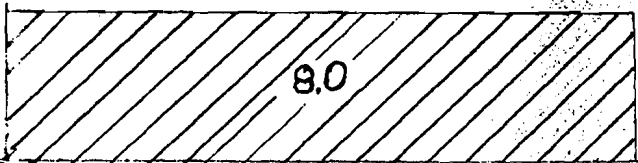

8.0

1401

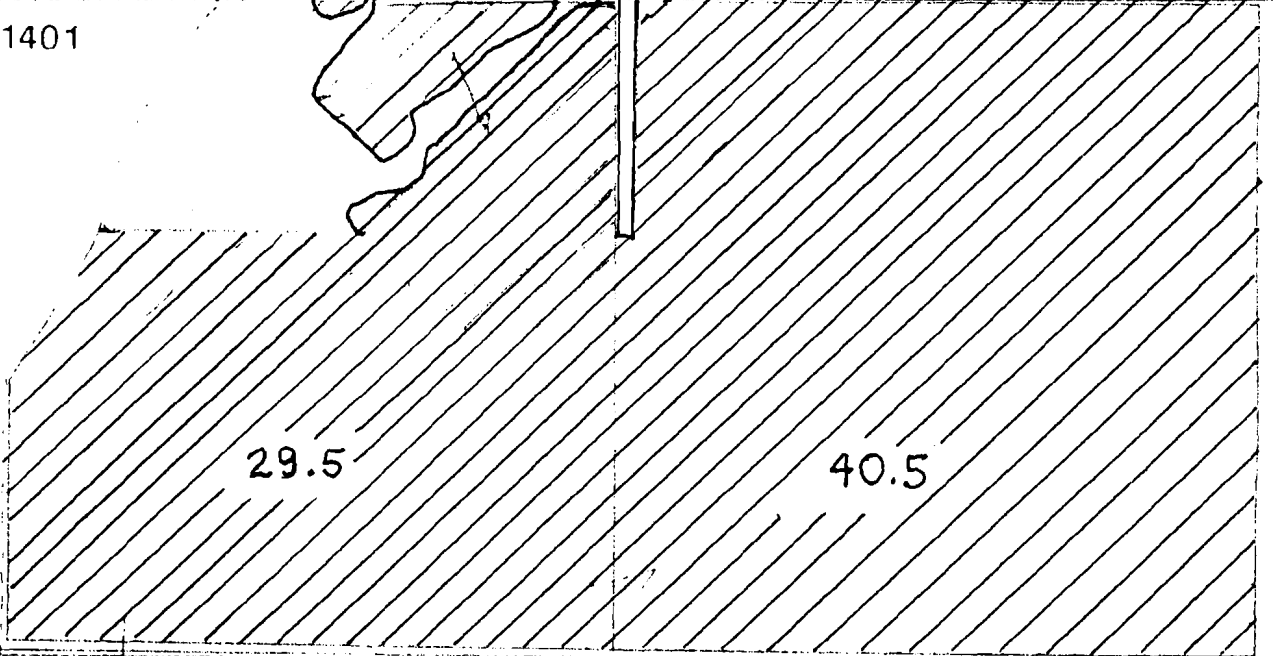

29.5

40.5

Section 18 SE 1/4 NE 1/4