

G.1092

13

35750

# T.27S.R.15E.W.M.

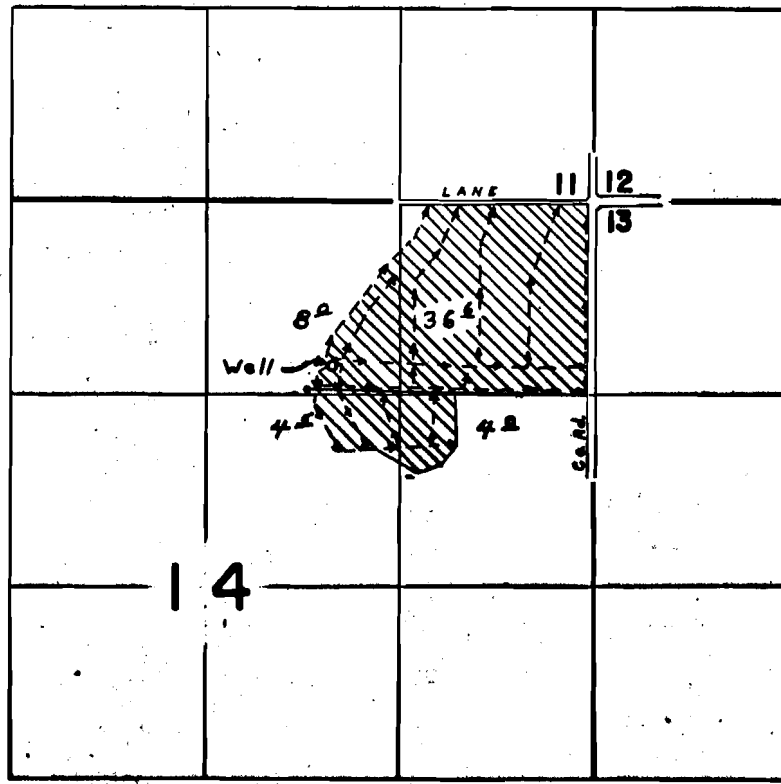

## FINAL PROOF SURVEY UNDER

Application No. G-1022. Permit No. G-1092.  
IN NAME OF

THELMA C. HEILMEYER OWSLEY

Surveyed JULY 31 1968, by L. E. GOULD.

CERTIFICATE 48608

SECTION 14, TOWNSHIP 27 SOUTH,  
RANGE 15 EAST, W.M.

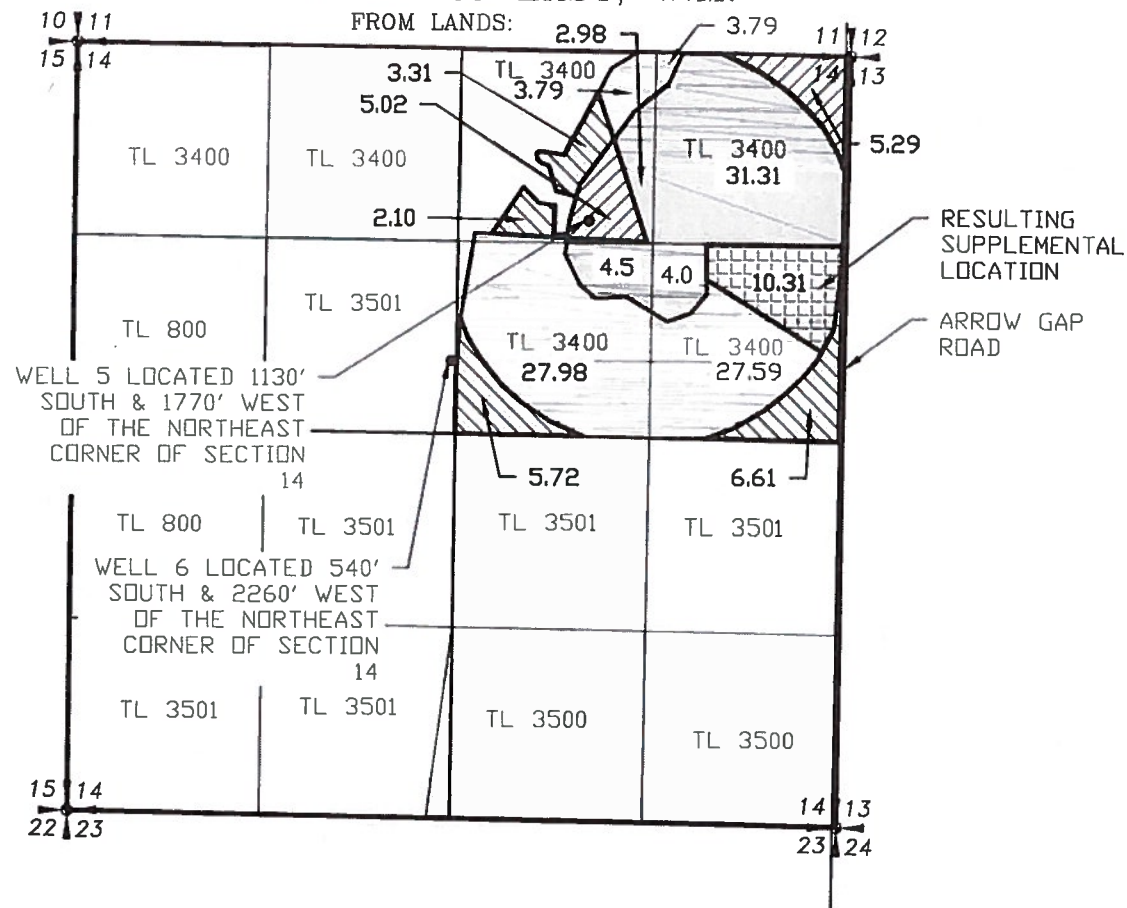

SECTION 18, TOWNSHIP 27 SOUTH,  
RANGE 16 EAST, W.M.

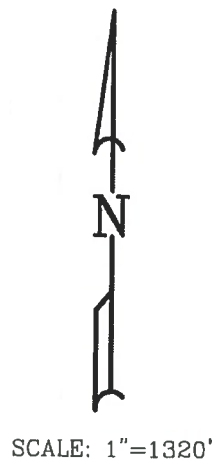
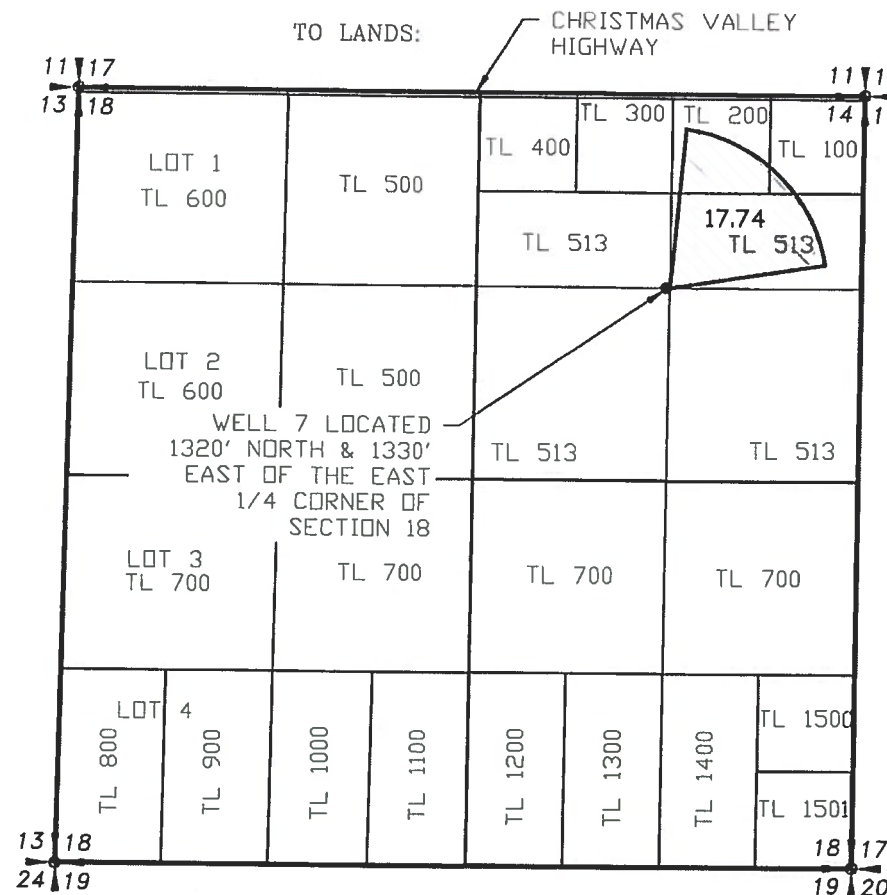

- LEGEND**
- SECTION LINE
  - 1/4 SECTION LINE
  - 1/16 SECTION LINE

TO TRANSFER:

Certificate	48608	Priority	8/9/1976							
Township	Range	Mer	Sec	Q-Q	GLot	Well #	Primary Acres	Supplemental Acres	Primary cfs	Supplemental cfs
27 S	15 E	W2	14	NE NE	6	6	0.9	31.31	0.00	0.33
27 S	15 E	W2	14	SW NE	6	6	3.79	2.98	0.00	0.00
27 S	15 E	W2	14	SE NE	6	6	27.98	4.5	0.33	0.00
27 S	15 E	W2	14	SE NE	6	6	6.61	4.0	0.34	0.00
Total Acres this Certificate							17.74	10.31	0.33	0.33
Total cfs									0.33	0.33



TO REMAIN:

Certificate	48608	Priority	8/9/1976							
Township	Range	Mer	Sec	Q-Q	GLot	Well #	Primary Acres	Supplemental Acres	Primary cfs	Supplemental cfs
27 S	15 E	W2	14	NE NE	6	6	0.9	31.31	0.00	0.33
27 S	15 E	W2	14	SW NE	6	6	3.79	2.98	0.00	0.00
27 S	15 E	W2	14	SW NE	6	6	27.98	4.5	0.33	0.00
27 S	15 E	W2	14	SE NE	6	6	27.59	4	0.34	0.00
Total Acres this Certificate							60.26	41.79	0.33	0.33
Total cfs									0.33	0.33



Received by OWRD

JUN 02 2020

Salem, OR

NEW LOCATION:

Certificate	48608	Priority	8/9/1976							
Township	Range	Mer	Sec	Q-Q	GLot	Well #	Primary Acres	Supplemental Acres	Primary cfs	Supplemental cfs
27 S	16 E	W2	18	SE NE	7	7	17.74	0.22	0.33	0.00
Total Acres this Certificate							17.74	0.22	0.33	0.00



Certificate	48608	Priority	8/9/1976						
Township	Range	Mer	Sec	Q-Q	GLot	Well #	Supplemental Acres	Supplemental cfs	Supplemental cfs
27 S	15 E	W2	14	SE NE	6	6	10.31	0.33	0.33
Total Acres this Certificate							10.31	0.33	0.33

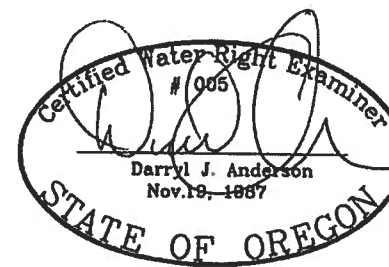

RENEWAL 12/31/21

NOTE:  
PREPARATION OF THIS MAP IS FOR IDENTIFYING WATER RIGHTS ONLY. IT HAS NO INTENT TO PROVIDE LOCATIONS OR DIMENSIONS OF PROPERTY BOUNDARIES.

REVISION	BY
5/28/2020	RC

**ANDERSON ENGINEERING AND SURVEYING, INC.**  
P.O. BOX 28  
LAKEVIEW, OREGON 97630  
(541) 947-4407  
FAX: 947-2321

FOR: DANIEL & LEANNE MILES  
81341 BUICK LANE  
SILVER LAKE, OR 97688

MAP TO ACCOMPANY  
TRANSFER APPLICATION  
CERTIFICATE 48608

DATE:	04/15/20
SCALE:	1"=1320'
DWG. BY:	R.C.
JOB:	2019-083
FILE:	2019-083
SHEET:	1 OF 1

SECTION 2, TOWNSHIP 27 SOUTH,  
RANGE 15 EAST, W.M.

WELL 4 LOCATED 2643.37'  
WEST & 4012.32' NORTH OF  
THE SOUTHEAST CORNER OF  
SECTION 2

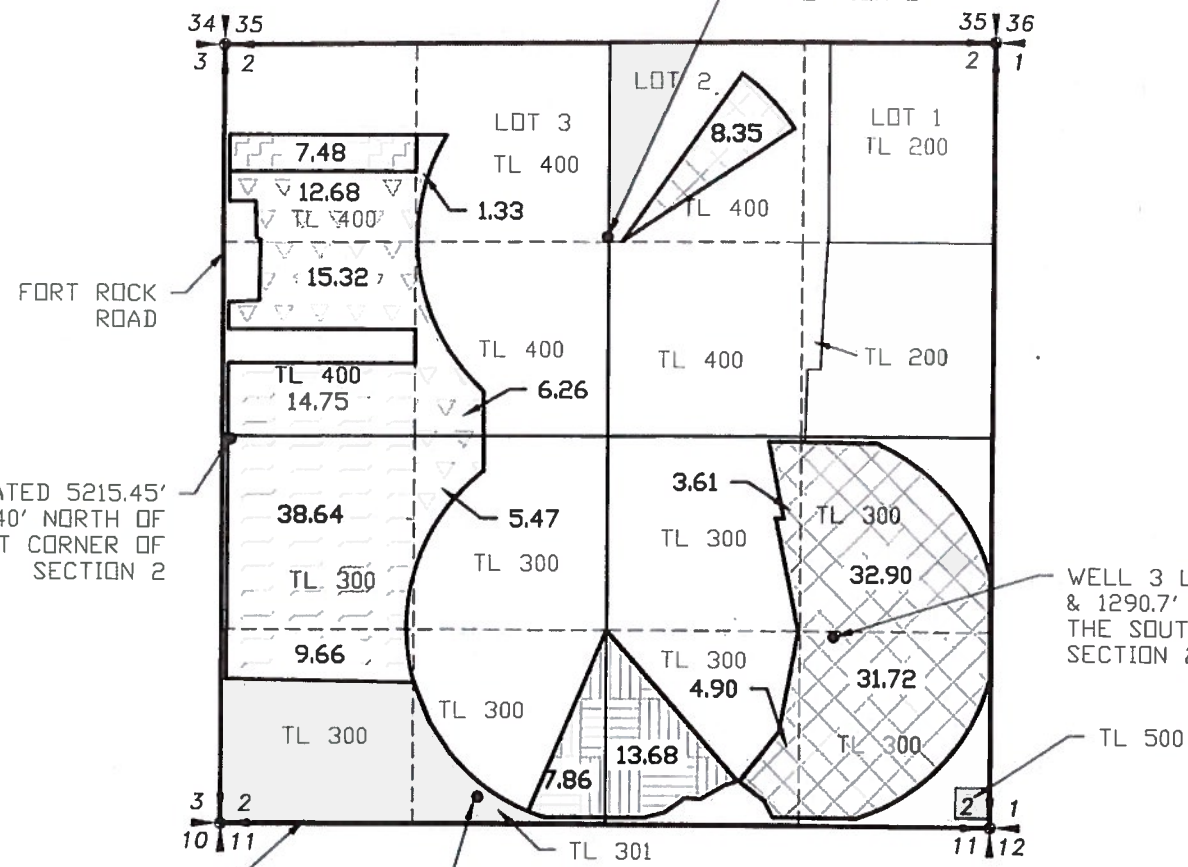

WELL 1 LOCATED 5215.45'  
WEST & 2627.40' NORTH OF  
THE SOUTHEAST CORNER OF  
SECTION 2

WELL 3 LOCATED 1089.8' WE  
& 1290.7' NORTH OF  
THE SOUTHEAST CORNER OF  
SECTION 2

WELL 2 LOCATED 3509.58'  
WEST & 187.26' NORTH OF THE  
SOUTHEAST CORNER OF  
SECTION 2

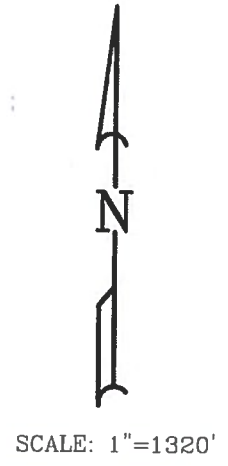

**LEGEND**  
 — SECTION LINE  
 — 1/4 SECTION LINE  
 - - - 1/16 SECTION LINE

Certificate	94837	Priority	1/5/1950					
Township	Range	Mer	Sec	Q-Q	GLot	Well #	Acres	cf
27 S	15 E	W.M.	2	NWNE	2	4	8.35	0.104
27 S	15 E	W.M.	3	NESE	3	3	12.9	0.411
27 S	15 E	W.M.	3	NWSE	3	3	3.61	0.043
27 S	15 E	W.M.	3	SWSE	3	3	4.9	0.063
27 S	15 E	W.M.	3	SESE	3	3	14.75	0.307
Total Acres this Certificate							81.19	1.019

Certificate	94359	Priority	2/14/1974					
Township	Range	Mer	Sec	Q-Q	GLot	Well #	Acres	cf
27 S	15 E	W.M.	3	SWNW	3	1	14.75	0.18
27 S	15 E	W.M.	3	NWSE	3	1	38.64	0.48
27 S	15 E	W.M.	3	SWSW	3	1	9.66	0.13
Total Acres this Certificate							63.05	0.79

Certificate	94361	Priority	1/17/1955					
Township	Range	Mer	Sec	Q-Q	GLot	Well #	Acres	cf
27 S	15 E	W.M.	2	SESW	2	2	7.86	0.10
27 S	15 E	W.M.	2	SWSE	2	2	13.68	0.17
Total Acres this Certificate							21.54	0.27

Certificate	94362	Priority	4/10/1956					
Township	Range	Mer	Sec	Q-Q	GLot	Well #	Acres	cf
27 S	15 E	W.M.	3	SWNW	3	1	7.18	0.09
Total Acres this Certificate							7.18	0.09

Certificate	94365	Priority	2/6/1959					
Township	Range	Mer	Sec	Q-Q	GLot	Well #	Acres	cf
27 S	15 E	W.M.	3	NESE	3	1	1.33	0.02
27 S	15 E	W.M.	3	SWNW	3	1	2.16	0.03
27 S	15 E	W.M.	3	SWNW	3	1	12.32	0.16
27 S	15 E	W.M.	3	SESW	3	1	6.26	0.08
27 S	15 E	W.M.	3	NESE	3	1	4.9	0.06
Total Acres this Certificate							48.24	0.61

SECTION 14, TOWNSHIP 27 SOUTH,  
RANGE 15 EAST, W.M.

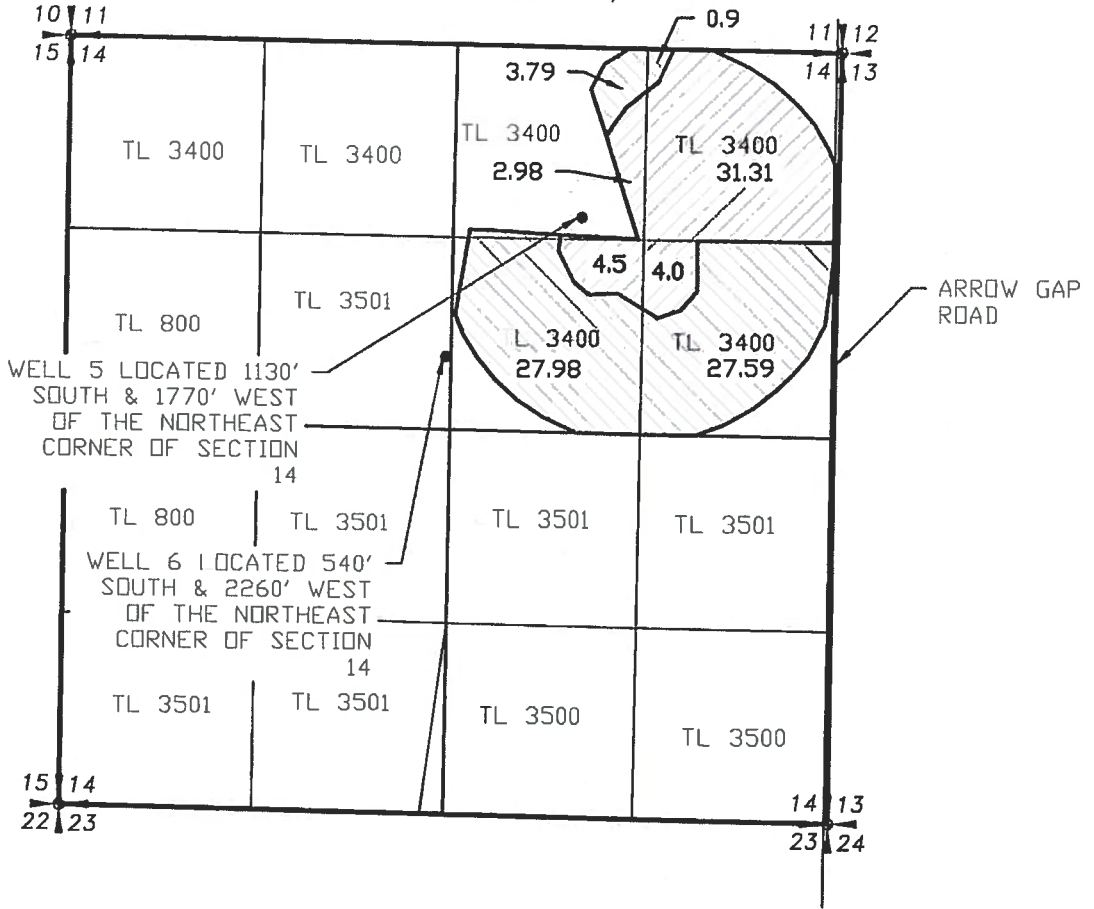

WELL 5 LOCATED 1130'  
SOUTH & 1770' WEST  
OF THE NORTHEAST  
CORNER OF SECTION  
14

WELL 6 LOCATED 540'  
SOUTH & 2260' WEST  
OF THE NORTHEAST  
CORNER OF SECTION  
14

Certificate	48608	Priority	8/9/1976							
Township	Range	Mer	Sec	Q-Q	GLot	Well #	Priority Acres	Supplemental Acres	Priority cfs	Supplemental cfs
27 S	15 E	W.M.	14	SENE	6	0	0	31.31	0.01	0.34
27 S	15 E	W.M.	14	SENE	6	0	0	0	0.02	0.4
27 S	15 E	W.M.	14	SWNE	6	0	27.98	4.0	0.3	0.4
27 S	15 E	W.M.	14	SENE	6	0	27.59	4.0	0.3	0.4
Total Acres this Certificate							60.16	42.79	0.75	0.54
									1.29	

Certificate	35750	Priority	11/6/1958					
Township	Range	Mer	Sec	Q-Q	GLot	Well #	Acres	cf
27 S	15 E	W.M.	14	NESE	5	0	31.31	0.39
27 S	15 E	W.M.	14	NWSE	5	0	2.98	0.03
27 S	15 E	W.M.	14	SWNE	5	0	4.0	0.05
27 S	15 E	W.M.	14	SENE	5	0	4.0	0.05
Total Acres this Certificate							42.79	0.53

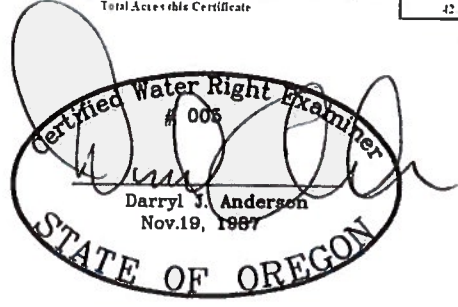

RENEWAL 12/31/21

Received by OWRD  
JUN 02 2020  
Salem, OR

NOTE:  
PREPARATION OF THIS MAP IS FOR  
IDENTIFYING WATER RIGHTS ONLY. IT  
HAS NO INTENT TO PROVIDE  
LOCATIONS OR DIMENSIONS OF  
PROPERTY BOUNDARIES.

REVISION	BY
5/28/2020	RC

**ANDERSON ENGINEERING  
AND SURVEYING, INC.**  
 P.O. BOX 28  
 LAKEVIEW, OREGON 97630  
 (541) 947-4407  
 FAX: 947-2321

FOR:  
DANIEL & LEANNE MILES  
81341 BUCK LANE  
SILVER LAKE, OR  
97638

**MAP TO ACCOMPANY  
TRANSFER APPLICATION  
AREAS TO REMAIN**

DATE:	04/15/20
SCALE:	1"=1320'
DWG. BY:	R.C.
JOB:	2019-083
FILE:	2019-083
SHEET:	4 OF 4

SECTION 18, TOWNSHIP 27 SOUTH,  
RANGE 16 EAST, W.M.

SECTION 2, TOWNSHIP 27 SOUTH,  
RANGE 15 EAST, W.M.

SECTION 14, TOWNSHIP 27 SOUTH,  
RANGE 15 EAST, W.M.

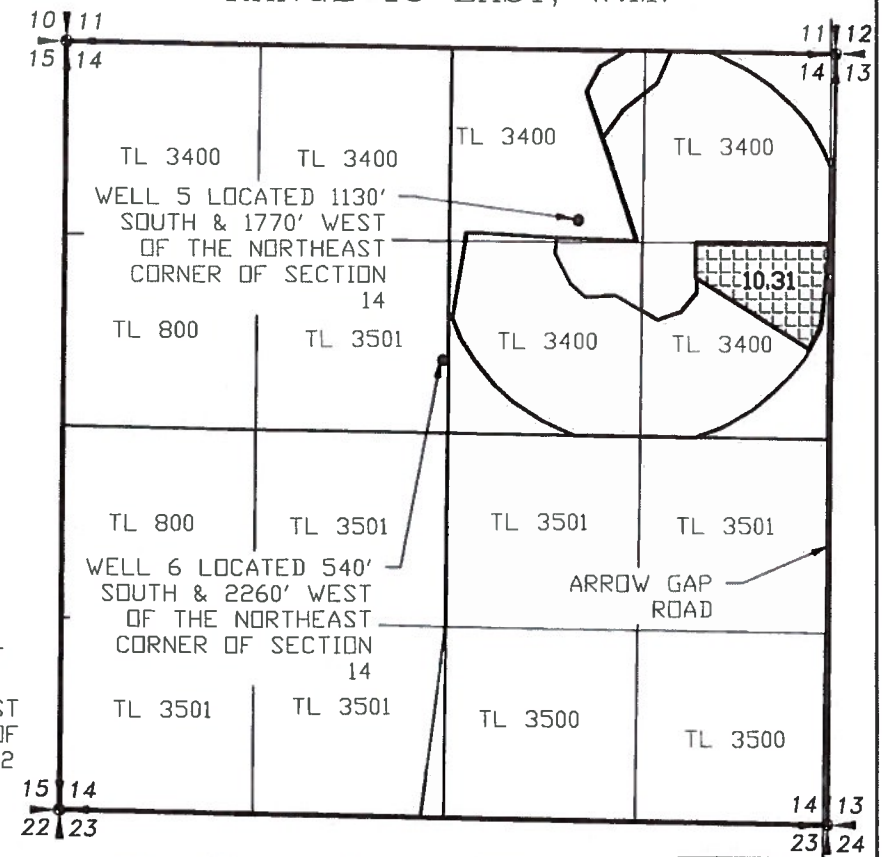
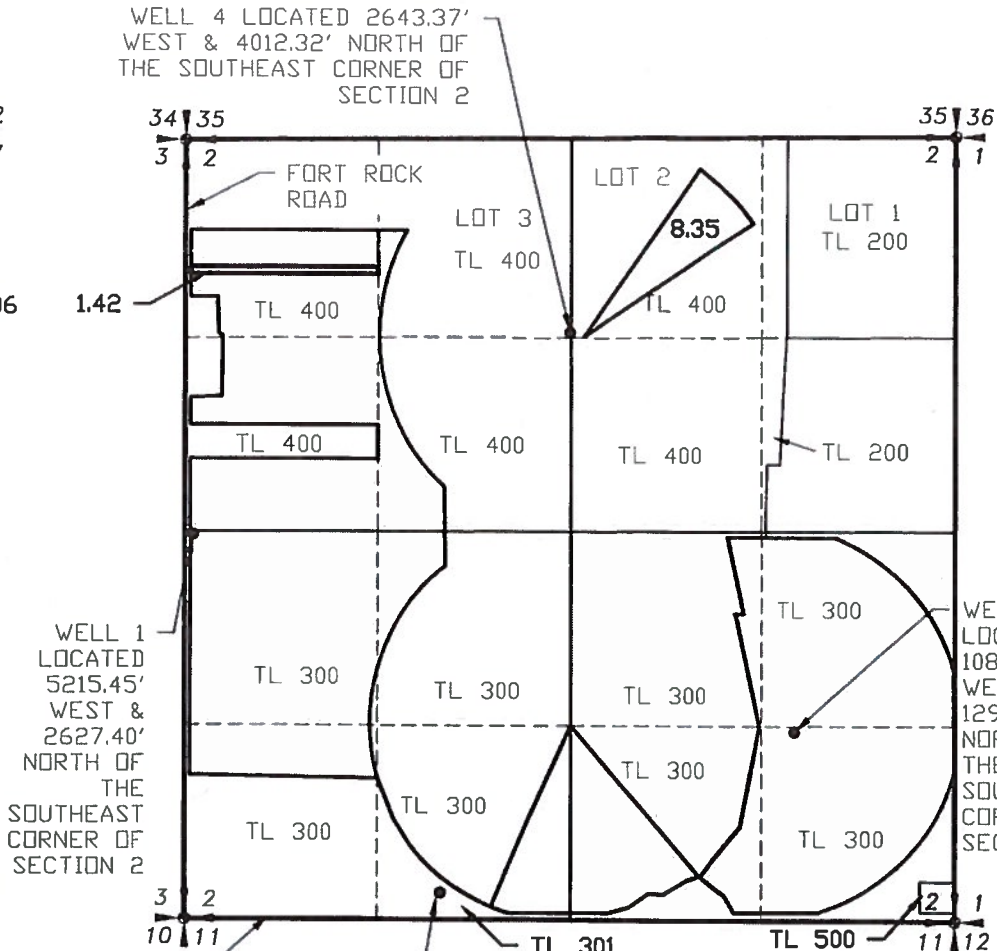
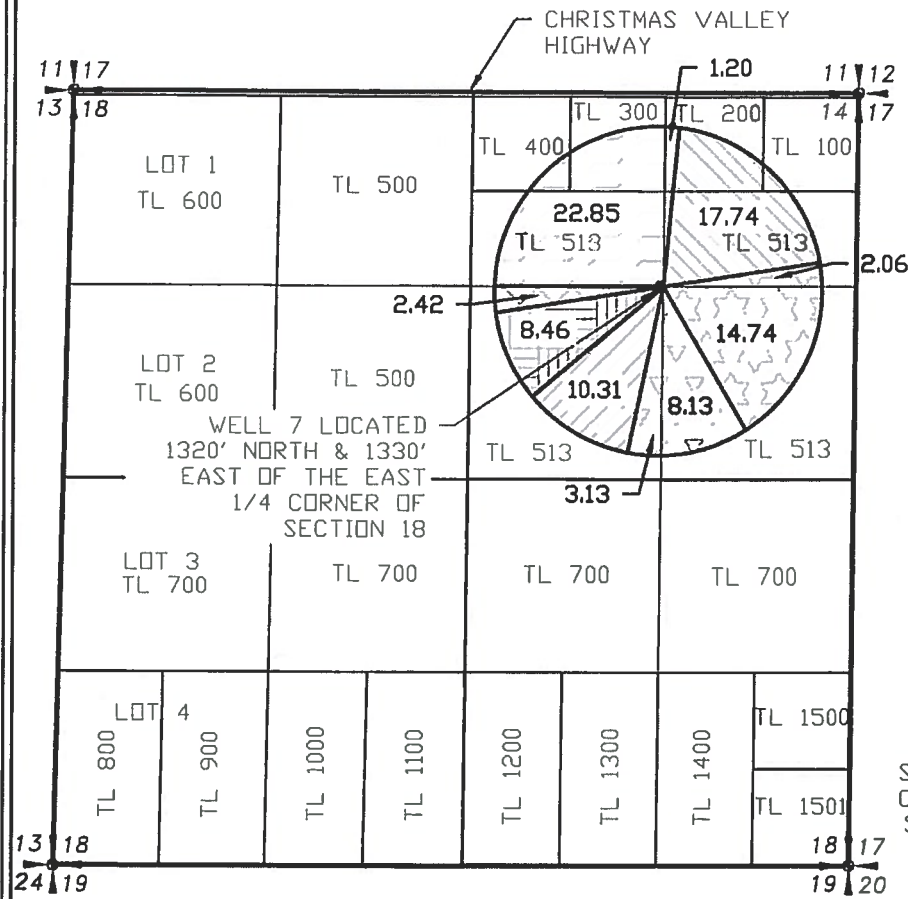

Certificate	Range	Mer	Sec	Q-Q	GLot	Well #	Acres	cfs
94357	16E	W3/4	18	SW-NE	7	?	2.42	0.01
94357	16E	W3/4	18	SE-NE	7	?	8.46	0.01
Total Acres this Certificate								0.02

Certificate	Range	Mer	Sec	Q-Q	GLot	Well #	Acres	cfs
94359	16E	W3/4	18	NE-NE	7	?	1.7	0.02
94359	16E	W3/4	18	NW-NE	7	?	22.8	0.26
Total Acres this Certificate								0.28

Certificate	Range	Mer	Sec	Q-Q	GLot	Well #	Acres	cfs
94361	16E	W3/4	18	SW-NE	7	?	8.46	0.14
Total Acres this Certificate								0.14

Certificate	Range	Mer	Sec	Q-Q	GLot	Well #	Primary Acres	Primary cfs
94362	16E	W3/4	18	NE-NE	7	?	7.08	0.05
94362	16E	W3/4	18	SE-NE	7	?	14.74	0.18
Total Acres this Certificate								0.23

Certificate	Range	Mer	Sec	Q-Q	GLot	Well #	Acres	cfs
94365	16E	W3/4	18	SW-NE	7	?	8.13	0.11
94365	16E	W3/4	18	SE-NE	7	?	3.13	0.04
Total Acres this Certificate								0.15

Certificate	Range	Mer	Sec	Q-Q	GLot	Well #	Primary Acres	Primary cfs
49608	16E	W3/4	18	NE-NE	7	?	17.74	0.23
Total Acres this Certificate								0.23

Certificate	Range	Mer	Sec	Q-Q	GLot	Well #	Acres	cfs
35750	16E	W3/4	18	SW-NE	7	?	10.31	0.13
Total Acres this Certificate								0.13

Certificate	Range	Mer	Sec	Q-Q	GLot	Well #	Supplemental Acres	Supplemental cfs
94362	16E	W3/4	18	SW-NE	7	?	1.42	0.02
Total Acres this Certificate								0.02

Certificate	Range	Mer	Sec	Q-Q	GLot	Well #	Supplemental Acres	Supplemental cfs
49608	16E	W3/4	18	NE-NE	7	?	10.31	0.13
Total Acres this Certificate								0.13

- LEGEND**
- SECTION LINE
  - 1/4 SECTION LINE
  - 1/16 SECTION LINE



RENEWAL 12/31/21

Received by OWRD

JUN 02 2020

Salem, OR

SCALE: 1"=1320'

NOTE:  
PREPARATION OF THIS MAP IS FOR IDENTIFYING WATER RIGHTS ONLY. IT HAS NO INTENT TO PROVIDE LOCATIONS OR DIMENSIONS OF PROPERTY BOUNDARIES.

REVISION	BY
5/28/2020	RC

**ANDERSON ENGINEERING AND SURVEYING, INC.**  
P.O. BOX 28  
LAKEVIEW, OREGON 97630  
(541) 947-4407  
FAX: 947-2321

FOR:  
DANIEL & LEANNE MILES  
81841 BUICK LANE  
SILVER LAKE, OR 97668

MAP TO ACCOMPANY  
TRANSFER APPLICATION  
RESULTING LOCATIONS

DATE:	04/15/20
SCALE:	1"=1320'
DWG. BY:	R.C.
JOB:	2019-083
FILE:	2019-083
SHEET:	3 OF 4

SECTION 2, TOWNSHIP 27 SOUTH,  
RANGE 15 EAST, W.M.

WELL 4 LOCATED 2643.37'  
WEST & 4012.32' NORTH OF  
THE SOUTHEAST CORNER OF  
SECTION 2

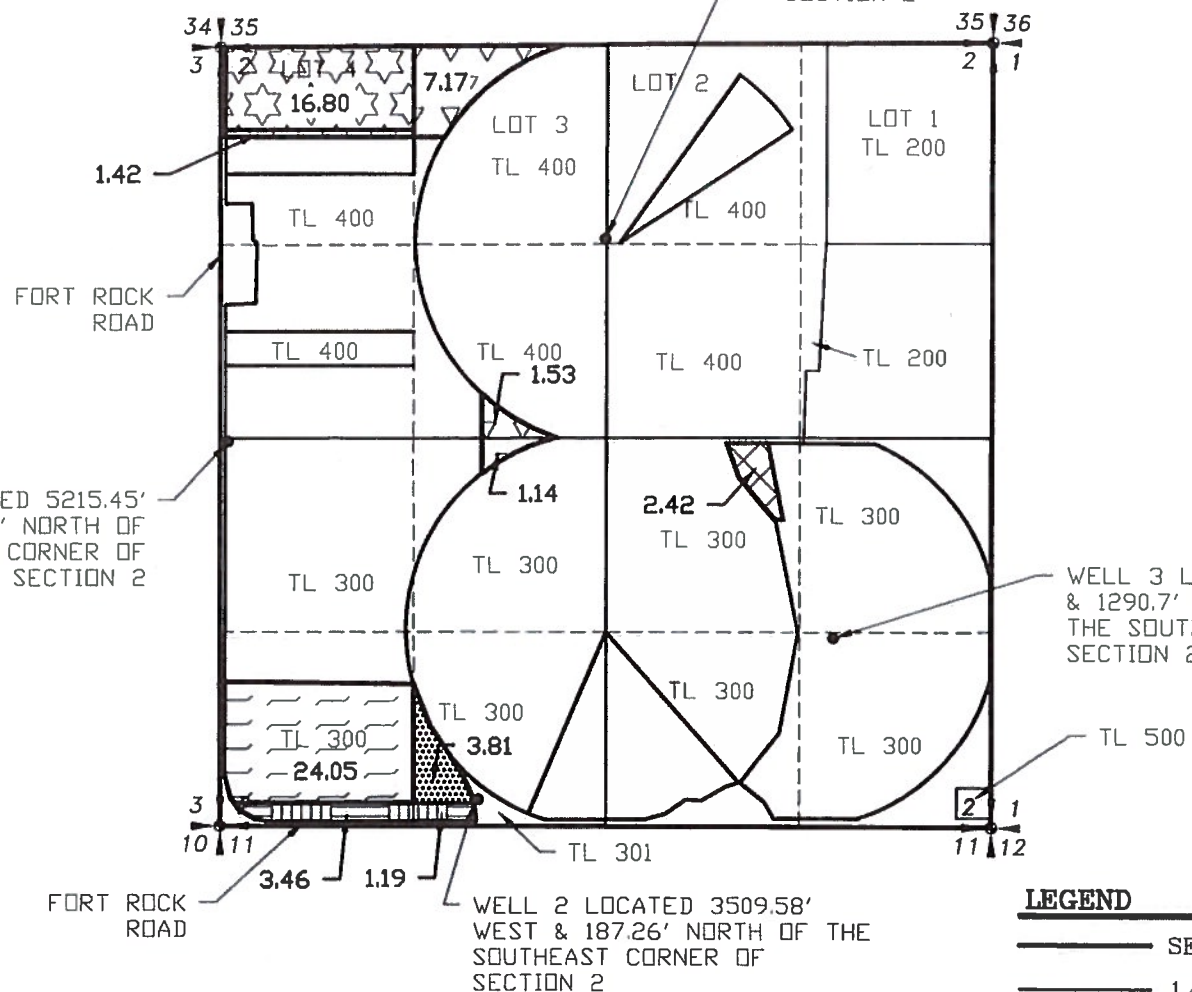

SCALE: 1"=1320'

- LEGEND**
- SECTION LINE
  - 1/4 SECTION LINE
  - - - 1/16 SECTION LINE

Certificate	94357	Priority	1/5/1950					
Township	Range	Mer	Sec	Q-Q	GLot	Well #	Acres	cfs
27 S	15 E	W.M.	14	NE	14	1	2.42	0.030
Total Acres this Certificate							2.42	0.030

Certificate	94362	Priority	4/10/1956							
Township	Range	Mer	Sec	Q-Q	GLot	Well #	Primary Acres	Supplemental Acres	Primary cfs	Supplemental cfs
27 S	15 E	W.M.	14	NW	14	1	16.2	1.42	0.21	0.05
Total Acres this Certificate							16.2	1.42	0.21	0.05
										0.23

Certificate	94359	Priority	2/14/1974					
Township	Range	Mer	Sec	Q-Q	GLot	Well #	Acres	cfs
27 S	15 E	W.M.	14	SW	14	1	24.05	0.31
Total Acres this Certificate							24.05	0.31

Certificate	94361	Priority	1/17/1955					
Township	Range	Mer	Sec	Q-Q	GLot	Well #	Acres	cfs
27 S	15 E	W.M.	14	SW	14	1	3.40	0.04
27 S	15 E	W.M.	14	SE	14	1	1.19	0.01
27 S	15 E	W.M.	14	SE	14	1	3.61	0.01
Total Acres this Certificate							8.20	0.11

WELL 1

WELL 2

Certificate	94365	Priority	7/6/1959					
Township	Range	Mer	Sec	Q-Q	GLot	Well #	Acres	cfs
27 S	15 E	W.M.	14	NE	14	1	7.17	0.08
27 S	15 E	W.M.	14	NW	14	1	1.4	0.01
27 S	15 E	W.M.	14	SE	14	1	1.52	0.02
27 S	15 E	W.M.	14	SE	14	1	1.14	0.01
Total Acres this Certificate							11.23	0.13

SECTION 14, TOWNSHIP 27 SOUTH,  
RANGE 15 EAST, W.M.

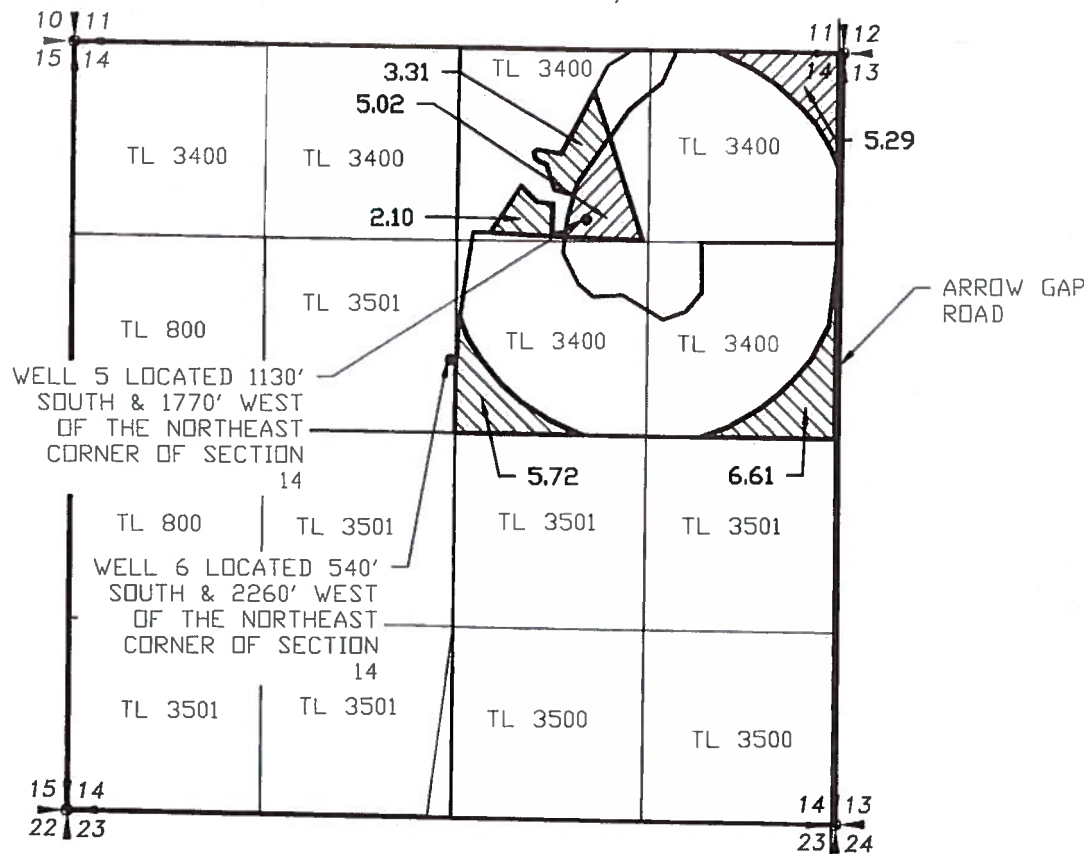

Certificate	48608	Priority	8/9/1976							
Township	Range	Mer	Sec	Q-Q	GLot	Well #	Primary Acres	Supplemental Acres	Primary cfs	Supplemental cfs
27 S	15 E	W.M.	14	NE	14	6	0	0	0	0
27 S	15 E	W.M.	14	NW	14	6	4.41	4.02	0.0	0.24
27 S	15 E	W.M.	14	SW	14	6	2.73	0	0.0	0.01
27 S	15 E	W.M.	14	SE	14	6	0.63	0	0.00	0.1
Total Acres this Certificate							17.74	10.31	0.32	0.13
										0.58

- PRIMARY
- SUPPLEMENTAL

Certificate	35750	Priority	11/6/1958					
Township	Range	Mer	Sec	Q-Q	GLot	Well #	Acres	cfs
27 S	15 E	W.M.	14	NE	14	6	5.29	
27 S	15 E	W.M.	14	NW	14	6	5.07	
Total Acres this Certificate							10.31	0.13

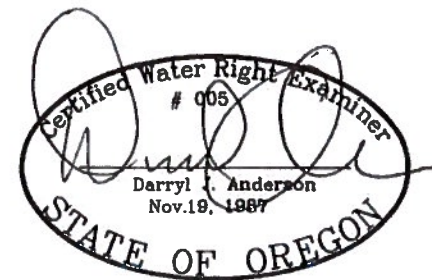

RENEWAL 12/31/21

NOTE:  
PREPARATION OF THIS MAP IS FOR  
IDENTIFYING WATER RIGHTS ONLY. IT  
HAS NO INTENT TO PROVIDE  
LOCATIONS OR DIMENSIONS OF  
PROPERTY BOUNDARIES.

Received by OWRD

JUN 02 2020

Salem, OR

REVISION	BY
5/28/2020	RC

**ANDERSON ENGINEERING  
AND SURVEYING, INC.**  
P.O. BOX 28  
LAKEVIEW, OREGON  
97630  
(541) 947-4407  
FAX: 947-2321

FOR:  
DANIEL & LEANNE MILES  
81341 BUICK LANE  
SILVER LAKE, OR  
97688

MAP TO ACCOMPANY  
TRANSFER APPLICATION  
AREAS TO TRANSFER

DATE:	04/15/20
SCALE:	1"=1320'
DWG. BY:	R.C.
JOB:	2019-083
FILE:	2019-083
SHEET:	2 OF 4

13457

SECTION 2, TOWNSHIP 27 SOUTH,  
RANGE 15 EAST, W.M.

SECTION 14, TOWNSHIP 27 SOUTH,  
RANGE 15 EAST, W.M.

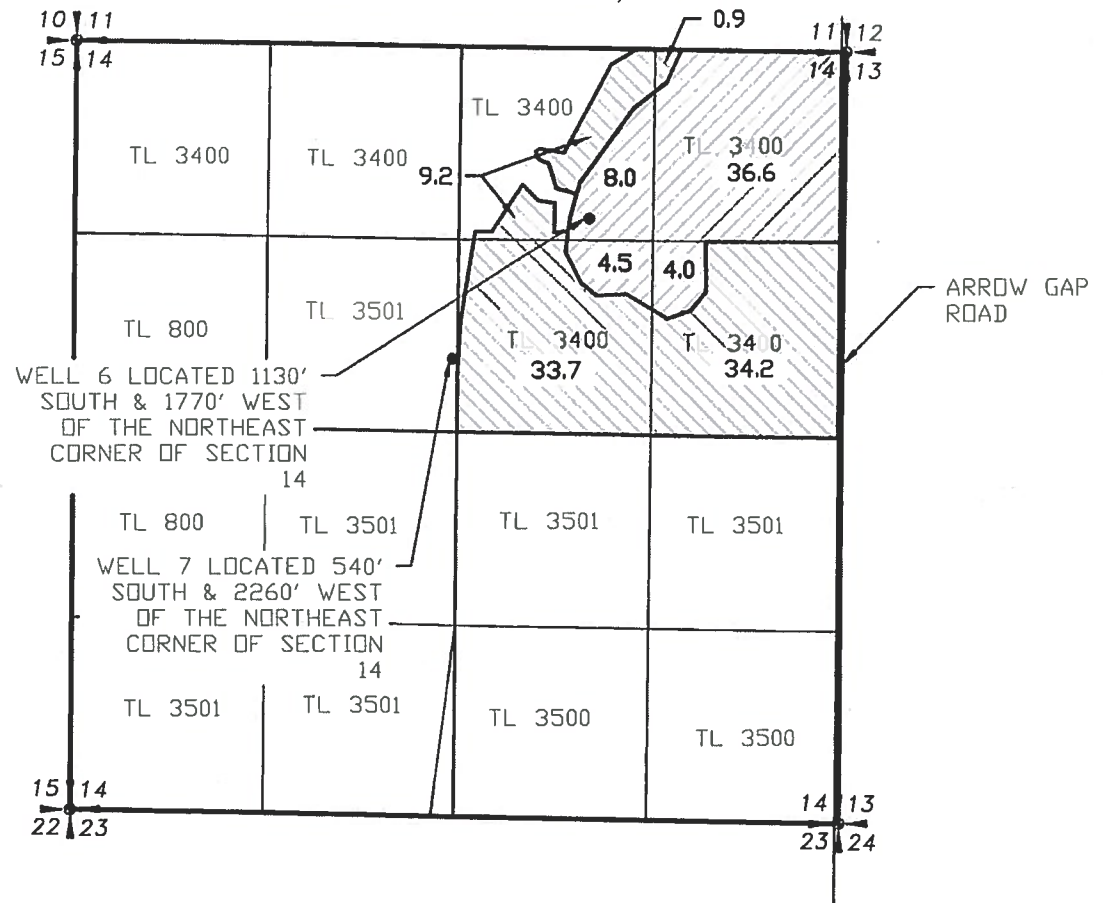
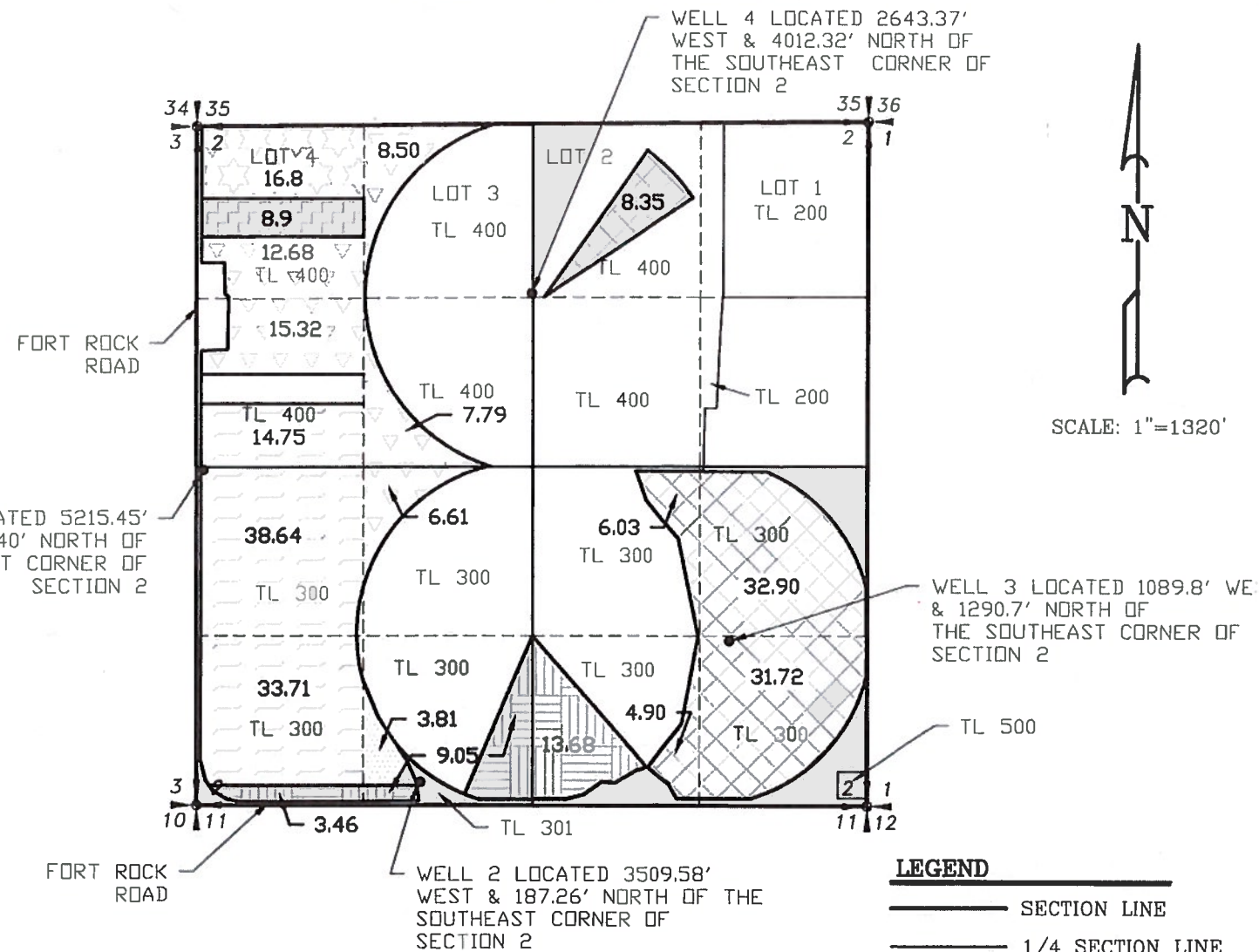

**LEGEND**

— SECTION LINE

— 1/4 SECTION LINE

- - - 1/16 SECTION LINE

Certificate	48608	Priority	8/9/1976							
Township	Range	Mer	Sec	Q-Q	GLot	Well #	Primary Acres	Supplemental Acres	Primary cfs	Supplemental cfs
27 S	15 E	WM	14	NNE		6	0.2	0	0.1	0.0
27 S	15 E	WM	14	SWNE		6	9.2	0	0.1	0.0
27 S	15 E	WM	14	SWNE		6	33.7	4	0.1	0.0
27 S	15 E	WM	14	SENE		6	34.2	4	0.1	0.0
Total Acres this Certificate							78	53.1	0.98	0.68
							Total cfs		1.68	

PRIMARY

SUPPLEMENTAL

Certificate	94357	Priority	1/5/1950					
Township	Range	Mer	Sec	Q-Q	GLot	Well #	Acres	cfs
27 S	15 E	WM	14	SWNE	2	2	8.35	0.10
27 S	15 E	WM	14	SESE	2	3	12.4	0.11
27 S	15 E	WM	14	SWSE	3	3	8.03	0.27
27 S	15 E	WM	14	SWSE	3	4	2.4	0.04
27 S	15 E	WM	14	SESE	3	11	11.2	0.18
Total Acres this Certificate							83.9	1.049

Certificate	94362	Priority	4/10/1956							
Township	Range	Mer	Sec	Q-Q	GLot	Well #	Primary Acres	Supplemental Acres	Primary cfs	Supplemental cfs
27 S	15 E	WM	14	NW NW	4	1	16.8	8.9	0.21	0.11
Total Acres this Certificate							16.8	8.9	0.71	0.11
							Total cfs		0.32	

PRIMARY

SUPPLEMENTAL

Certificate	94359	Priority	2/14/1974					
Township	Range	Mer	Sec	Q-Q	GLot	Well #	Acres	cfs
27 S	15 E	WM	14	SW NW		1	14.7	0.18
27 S	15 E	WM	14	NW SW		1	38.64	0.18
27 S	15 E	WM	14	SW SW		1	33.71	0.12
Total Acres this Certificate							87.1	1.08

Certificate	35750	Priority	11/6/1958					
Township	Range	Mer	Sec	Q-Q	GLot	Well #	Acres	cfs
27 S	15 E	WM	14	NW		5	5	0.1
27 S	15 E	WM	14	NWNE		4	4	0.1
27 S	15 E	WM	14	SWNE		5	5	0.1
27 S	15 E	WM	14	SENE		5	5	0.1
Total Acres this Certificate							53.1	0.6

Received by OWRD

Certificate	94361	Priority	1/17/1955					
Township	Range	Mer	Sec	Q-Q	GLot	Well #	Acres	cfs
27 S	15 E	WM	14	SW SW		2	3.46	0.04
27 S	15 E	WM	14	SW SW		2	9.05	0.11
27 S	15 E	WM	14	SE SW		1	13.68	0.08
27 S	15 E	WM	14	SW SE		2	13.68	0.12
Total Acres this Certificate							30	0.35

WELL 1

WELL 2

Certificate	94365	Priority	2/6/1959					
Township	Range	Mer	Sec	Q-Q	GLot	Well #	Acres	cfs
27 S	15 E	WM	14	NW NW		1	8	0.11
27 S	15 E	WM	14	NW NW		4	11.53	0.17
27 S	15 E	WM	14	SW NW		1	13.52	0.15
27 S	15 E	WM	14	SE NW		1	7.3	0.11
27 S	15 E	WM	14	SE SW		1	6.61	0.08
Total Acres this Certificate							59.5	0.75

PRIMARY

PRIMARY



JUN 02 2020

Salem, OR

NOTE: PREPARATION OF THIS MAP IS FOR IDENTIFYING WATER RIGHTS ONLY. IT HAS NO INTENT TO PROVIDE LOCATIONS OR DIMENSIONS OF PROPERTY BOUNDARIES.

REVISION	BY
5/28/2020	RC

**ANDERSON ENGINEERING AND SURVEYING, INC.**  
P.O. BOX 28  
LAKEVIEW, OREGON 97630  
(541) 947-4407  
FAX: 947-2321

FOR: DANIEL & LEANNE MIDES  
81341 BUICK LANE  
SILVER LAKE, OR 97638

MAP TO ACCOMPANY  
TRANSFER APPLICATION  
ORIGINAL CERTIFICATE LAYOUTS

DATE:	04/15/20
SCALE:	1"=1320'
DWG. BY:	R.C.
JOB:	2019-083
FILE:	2019-083
SHEET:	1 OF 4

94357																														
Township	Range	Sec	Q-Q	Taxlot	GLot	Acres	Use	POA Well	Priority	Proposed Change	Township	Range	Sec	Q-Q	Taxlot	GLot	Acres	Use	POA Well	Priority										
27	S	15	E	2	NW	SE	300		2.42	Irrigation	3	1/5/1950	POD/POU	27	S	16	E	18	SW	NE	513		2.42	Irrigation	7	1/5/1950				
						2.42																		2.42						

94359																														
Township	Range	Sec	Q-Q	Taxlot	GLot	Acres	Use	POA Well	Priority	Proposed Change	Township	Range	Sec	Q-Q	Taxlot	GLot	Acres	Use	POA Well	Priority										
27	S	15	E	2	SW	SW	300		24.05	Irrigation	1	2/14/1974	POD/POU	27	S	16	E	18	NE	NE	200, 513		1.2	Irrigation	7	2/14/1974				
						24.05																		24.05						

94361																														
Township	Range	Sec	Q-Q	Taxlot	GLot	Acres	Use	POA Well	Priority	Proposed Change	Township	Range	Sec	Q-Q	Taxlot	GLot	Acres	Use	POA Well	Priority										
27	S	15	E	2	SW	SW	300		3.46	Irrigation	2	1/17/1955	POD/POU	27	S	16	E	18	SW	NE	513		8.46	Irrigation	7	1/17/1955				
27	S	15	E	2	SE	SW	300		1.19	Irrigation	2	1/17/1955	POD/POU																	
27	S	15	E	2	SE	SW	300		3.81	Irrigation	1	1/17/1955	POD/POU																	
						8.46																		8.46						

94362																														
Township	Range	Sec	Q-Q	Taxlot	GLot	Primary Acres	Use	POA Well	Priority	Proposed Change	Township	Range	Sec	Q-Q	Taxlot	GLot	Primary Acres	Use	POA Well	Priority										
27	S	15	E	2	NW	NW	400	4	16.8	Primary Irrigation				4/10/1956	POD/POU	27	S	16	E	18	NW	NE	513		2.06	Primary Irrigation	7	4/10/1956		
						16.8																		16.8						

94362																														
Township	Range	Sec	Q-Q	Taxlot	GLot	Supplemental Acres	Use	POA Well	Priority	Proposed Change	Township	Range	Sec	Q-Q	Taxlot	GLot	Supplemental Acres	Use	POA Well	Priority										
27	S	15	E	2	NW	NW	400	4	1.42	Supplemental Irrigation				4/10/1956	POU	27	S	15	E	2	NW	NW	400	4	1.42	Supplemental Irrigation	1	4/10/1956		
						1.42																		1.42						

94365																														
Township	Range	Sec	Q-Q	Taxlot	GLot	Acres	Use	POA Well	Priority	Proposed Change	Township	Range	Sec	Q-Q	Taxlot	GLot	Acres	Use	POA Well	Priority										
27	S	15	E	2	NE	NW	400	3	7.17	Irrigation	1	2/6/1959	POD/POU	27	S	16	E	18	SW	NE	513		3.13	Irrigation	7	2/6/1959				
27	S	15	E	2	NW	NW	400	4	1.42	Irrigation	1	2/6/1959	POD/POU	27	S	16	E	18	SE	NE	513		8.13	Irrigation	7	2/6/1959				
27	S	15	E	2	SE	NW	400		1.53	Irrigation	1	2/6/1959	POD/POU																	
27	S	15	E	2	NE	SW	300		1.14	Irrigation	1	2/6/1959	POD/POU																	
						11.26																		11.26						

35750																														
Township	Range	Sec	Q-Q	Taxlot	GLot	Acres	Use	POA Well	Priority	Proposed Change	Township	Range	Sec	Q-Q	Taxlot	GLot	Acres	Use	POA Well	Priority										
27	S	15	E	14	NE	NE	3400		5.29	Irrigation	5	11/6/1958	POD/POU	27	S	16	E	18	SW	NE	513		10.31	Irrigation	7	11/6/1958				
27	S	15	E	14	NW	NE	3400		5.02	Irrigation	5	11/6/1958	POD/POU																	
						10.31																		10.31						

48606																														
Township	Range	Sec	Q-Q	Taxlot	GLot	Primary Acres	Use	POA Well	Priority	Proposed Change	Township	Range	Sec	Q-Q	Taxlot	GLot	Acres	Primary Acres	POA Well	Priority										
27	S	15	E	14	NW	NE	3400		5.41	Primary Irrigation	6	8/9/1976	POD/POU	27	S	16	E	18	NE	NE	100, 200, 513		17.74	Primary Irrigation	7	8/9/1976				
27	S	15	E	14	SW	NE	3400		5.72	Primary Irrigation	6	8/9/1976	POD/POU																	
27	S	15	E	14	SE	NE	3400		6.61	Primary Irrigation	6	8/9/1976	POD/POU																	
						17.74																		17.74						

48606																														
Township	Range	Sec	Q-Q	Taxlot	GLot	Supplemental Acres	Use	POA Well	Priority	Proposed Change	Township	Range	Sec	Q-Q	Taxlot	GLot	Supplemental Acres	Use	POA Well	Priority										
27	S	15	E	14	NE	NE	3400		5.29	Supplemental Irrigation	6	8/9/1976	POU	27	S	15	E	14	SE	NE	3400		10.31	Supplemental Irrigation	6	8/9/1976				
27	S	15	E	14	NW	NE	3400		5.02	Supplemental Irrigation	6	8/9/1976	POU																	
						10.31																		10.31						

RECEIVED  
MAY 26 2020  
OWRD

SECTION 2, TOWNSHIP 27 SOUTH,  
RANGE 15 EAST, W.M.

WELL 4 LOCATED 2643.37'  
WEST & 4012.32' NORTH OF  
THE SOUTHEAST CORNER OF  
SECTION 2

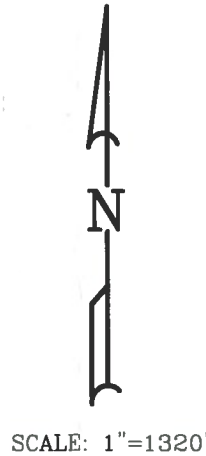
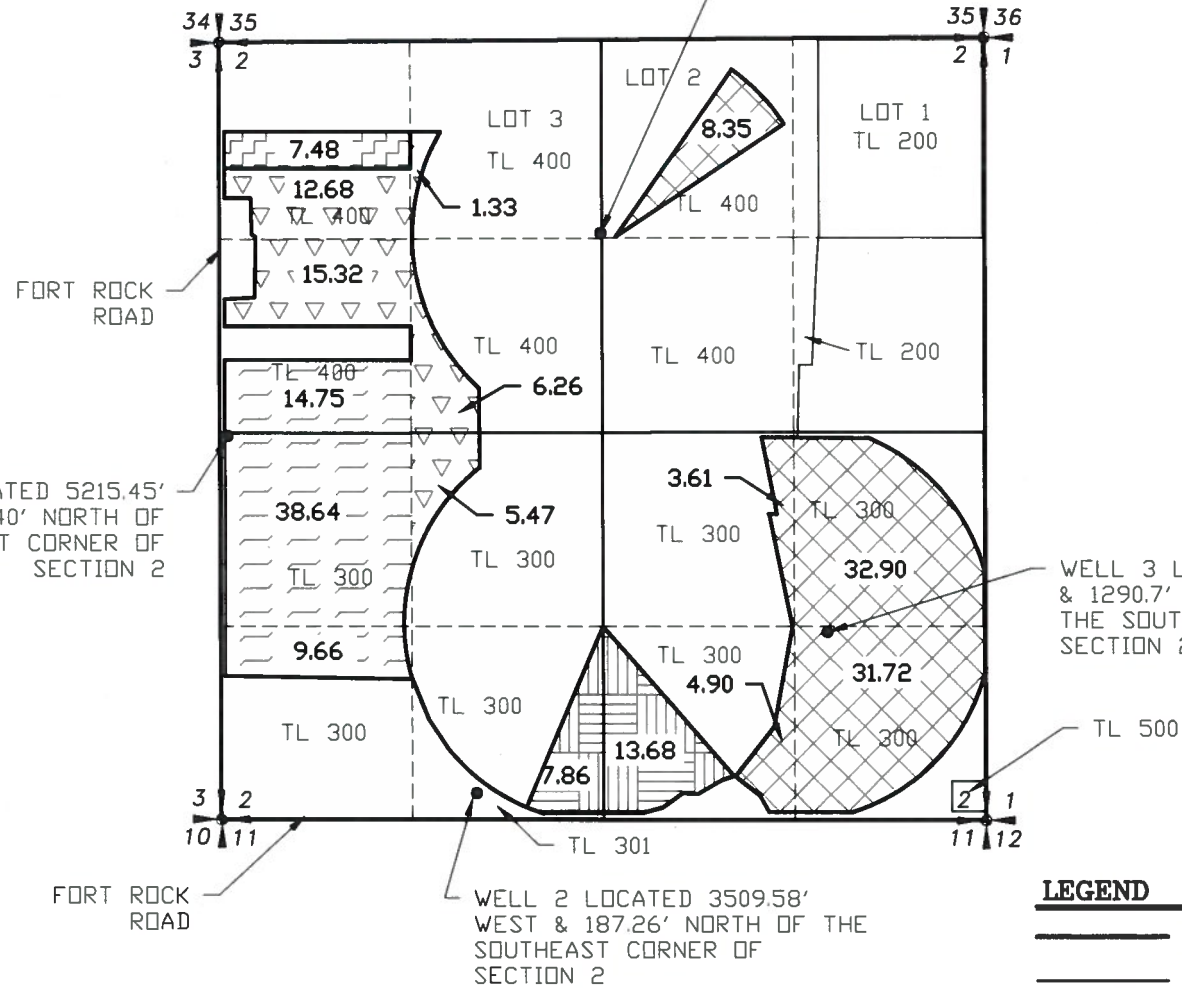

SECTION 14, TOWNSHIP 27 SOUTH,  
RANGE 15 EAST, W.M.

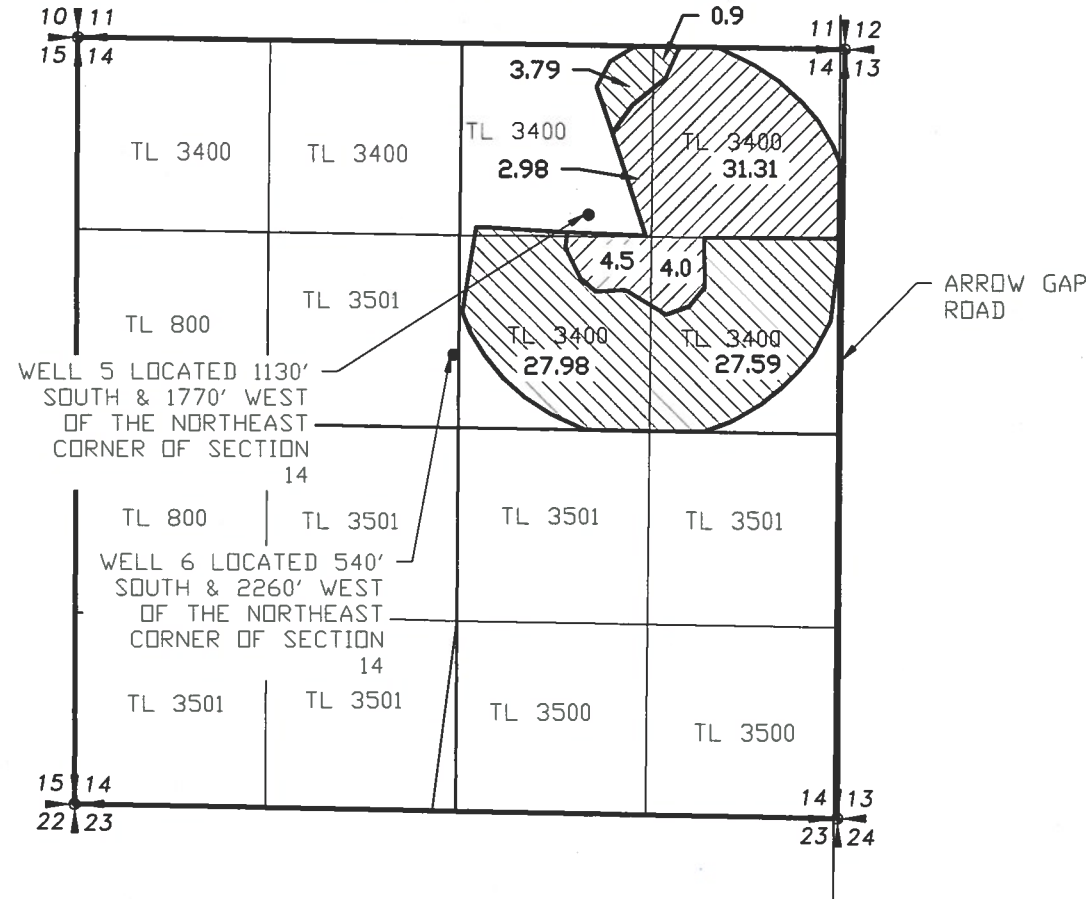

**LEGEND**  
 — SECTION LINE  
 — 1/4 SECTION LINE  
 - - - 1/16 SECTION LINE

Certificate	48606				Priority	8/9/1976				
Township	Range	Mer	Sec	Q-Q	GLot	Well #	Primary Acres	Supplemental Acres	Primary cfs	Supplemental cfs
27 S	15 E	WM	14	NENE		6	0.9	31.31	0.01	0.39
27 S	15 E	WM	14	NWNE		6	3.79	2.98	0.05	0.04
27 S	15 E	WM	14	SWNE		6	27.98	4.5	0.35	0.06
27 S	15 E	WM	14	SENE		6	27.59	4	0.34	0.05
Total Acres this Certificate							60.26	42.79	0.75	0.53
							Total cfs		1.29	



Certificate	94357				Priority	1/5/1950			
Township	Range	Mer	Sec	Q-Q	GLot	Well #	Acres	cfs	
27 S	15 E	WM	2	NWNE	2	4	8.35	0.104	
27 S	15 E	WM	2	NESE	3	3	12.9	0.411	
27 S	15 E	WM	2	NWSE	3	3	3.01	0.043	
27 S	15 E	WM	2	SWSE	3	3	4.9	0.061	
27 S	15 E	WM	2	SESE	3	3	31.72	0.397	
Total Acres this Certificate							81.48	1.019	

Certificate	94362				Priority	4/10/1956				
Township	Range	Mer	Sec	Q-Q	GLot	Well #	Primary Acres	Supplemental Acres	Primary cfs	Supplemental cfs
27 S	15 E	WM	2	NW NW	4	1	0	7.48	0.00	0.09
Total Acres this Certificate							0	7.48	0.00	0.09
							Total cfs		0.09	

Certificate	94359				Priority	2/14/1974			
Township	Range	Mer	Sec	Q-Q	GLot	Well #	Acres	cfs	
27 S	15 E	WM	2	SW NW	1	1	14.75	0.18	
27 S	15 E	WM	2	NW SW	1	1	38.64	0.48	
27 S	15 E	WM	2	SW SW	1	1	9.66	0.12	
Total Acres this Certificate							63.05	0.78	

Certificate	94365				Priority	2/6/1959			
Township	Range	Mer	Sec	Q-Q	GLot	Well #	Acres	cfs	
27 S	15 E	WM	2	NE NW	3	1	1.33	0.02	
27 S	15 E	WM	2	NW NW	4	1	20.16	0.25	
27 S	15 E	WM	2	SW NW	1	1	15.32	0.19	
27 S	15 E	WM	2	SE NW	1	1	6.26	0.08	
27 S	15 E	WM	2	NE SW	1	1	3.47	0.07	
Total Acres this Certificate							48.54	0.61	

Certificate	94361				Priority	1/17/1955			
Township	Range	Mer	Sec	Q-Q	GLot	Well #	Acres	cfs	
27 S	15 E	WM	2	SE SW	2	2	7.86	0.10	
27 S	15 E	WM	2	SW SE	2	2	13.68	0.17	
Total Acres this Certificate							21.54	0.27	

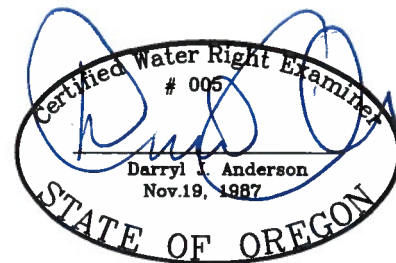
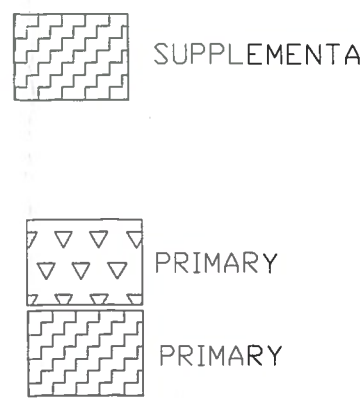

NOTE:  
PREPARATION OF THIS MAP IS FOR  
IDENTIFYING WATER RIGHTS ONLY. IT  
HAS NO INTENT TO PROVIDE  
LOCATIONS OR DIMENSIONS OF  
PROPERTY BOUNDARIES.

REVISION	BY

**ANDERSON ENGINEERING AND SURVEYING, INC.**  
 P.O. BOX 28  
 LAKEVIEW, OREGON 97630  
 (541) 947-4407  
 FAX: 947-2321

FOR:  
**DANIEL & LEANNE MILES**  
 81341 BUICK LANE  
 SILVER LAKE, OR  
 97638

**MAP TO ACCOMPANY  
 TRANSFER APPLICATION  
 AREAS TO REMAIN**

**RECEIVED  
 MAY 26 2020  
 OWRD**

DATE:	04/15/20
SCALE:	1"=1320'
DWG. BY:	R.C.
JOB:	2019-083
FILE:	2019-083
SHEET:	4 OF 4



SECTION 18, TOWNSHIP 27 SOUTH,  
RANGE 16 EAST, W.M.

SECTION 2, TOWNSHIP 27 SOUTH,  
RANGE 15 EAST, W.M.

SECTION 14, TOWNSHIP 27 SOUTH,  
RANGE 15 EAST, W.M.

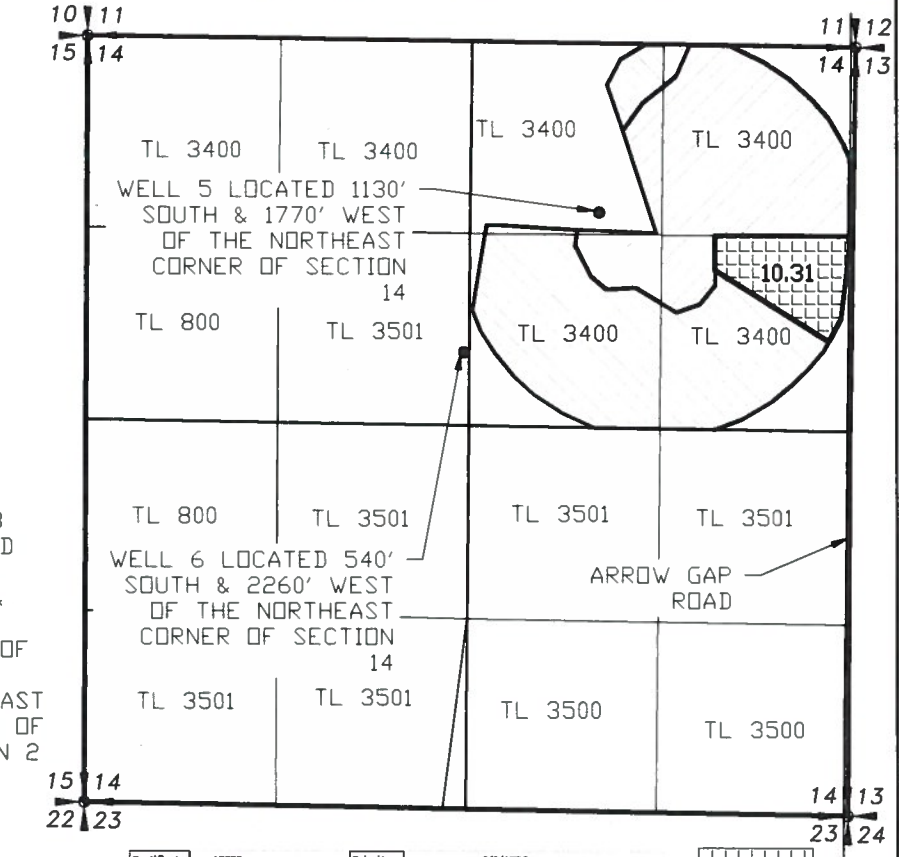
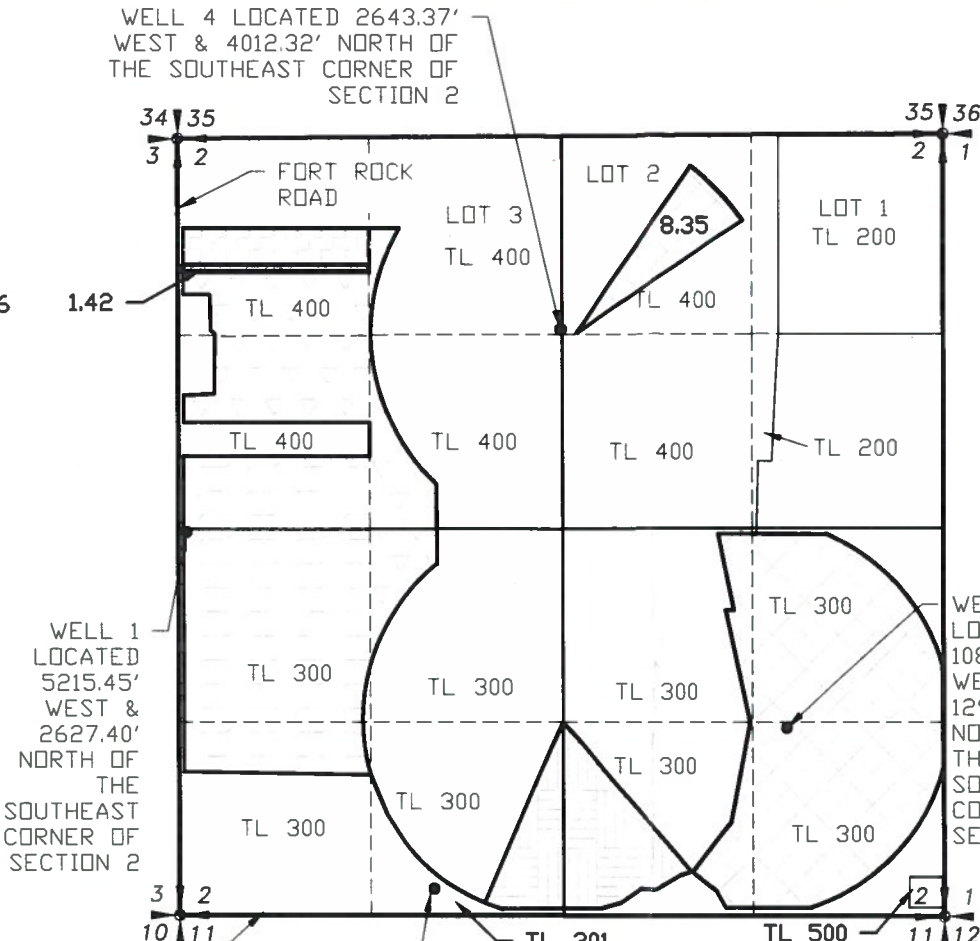
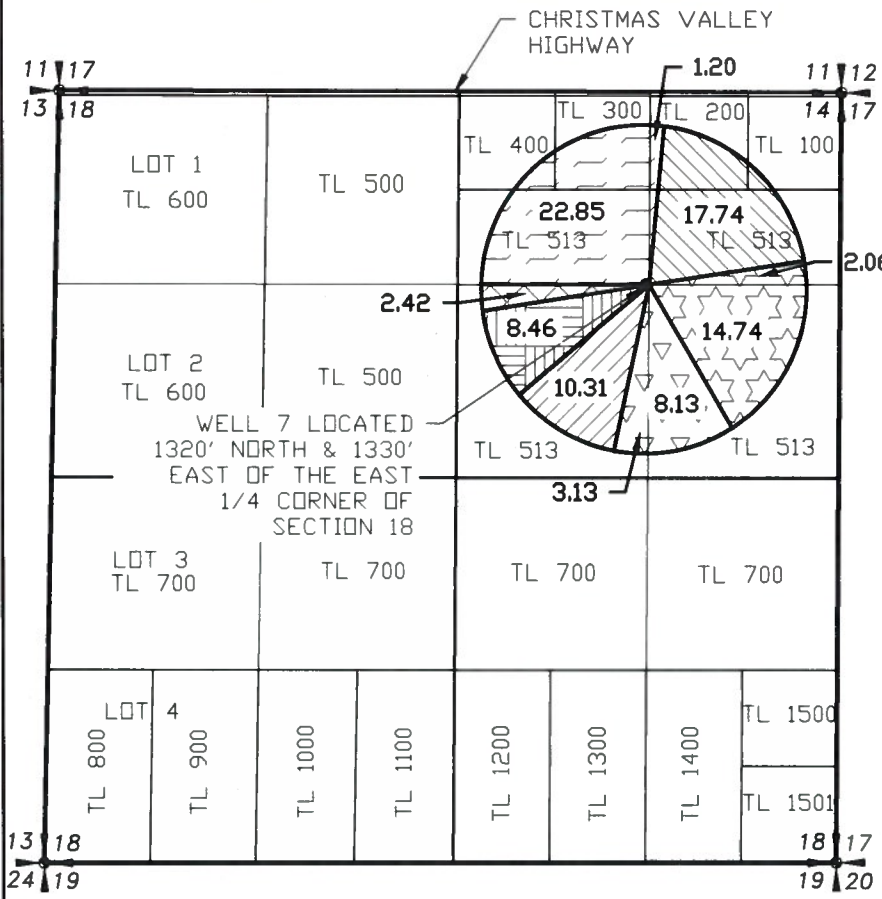

Certificate	94357	Priority	1/5/1950					
Township	Range	Mer	Sec	Q-Q	GLot	Well #	Acres	cf
27 S	16 E	W.M.	18 SW NE		7		2.42	0.03
27 S	16 E	W.M.	18 SE NE		7		0	0.00
Total Acres this Certificate							2.42	0.030

Certificate	94359	Priority	2/14/1974					
Township	Range	Mer	Sec	Q-Q	GLot	Well #	Acres	cf
27 S	16 E	W.M.	18 NE NE		7		1.2	0.02
27 S	16 E	W.M.	18 SW NE		7		22.85	0.29
Total Acres this Certificate							24.05	0.30

Certificate	94361	Priority	1/17/1955					
Township	Range	Mer	Sec	Q-Q	GLot	Well #	Acres	cf
27 S	16 E	W.M.	18 SW NE		7		8.46	0.11
Total Acres this Certificate							8.46	0.11

Certificate	94362	Priority	4/10/1956					
Township	Range	Mer	Sec	Q-Q	GLot	Well #	Primary Acres	Primary cf
27 S	16 E	W.M.	18 NE NE		7		2.06	0.03
27 S	16 E	W.M.	18 SE NE		7		14.74	0.18
Total Acres this Certificate							16.8	0.21

Certificate	94365	Priority	2/6/1959					
Township	Range	Mer	Sec	Q-Q	GLot	Well #	Acres	cf
27 S	16 E	W.M.	18 SW NE		7		8.13	0.10
27 S	16 E	W.M.	18 SE NE		7		3.13	0.04
Total Acres this Certificate							11.26	0.14

Certificate	48606	Priority	8/9/1976					
Township	Range	Mer	Sec	Q-Q	GLot	Well #	Primary Acres	Primary cf
27 S	16 E	W.M.	18 NE NE		7		17.74	0.22
Total Acres this Certificate							17.74	0.22

Certificate	35750	Priority	11/6/1958					
Township	Range	Mer	Sec	Q-Q	GLot	Well #	Acres	cf
27 S	16 E	W.M.	18 SW NE		7		10.31	0.13
Total Acres this Certificate							10.31	0.13

Certificate	94362	Priority	4/10/1956					
Township	Range	Mer	Sec	Q-Q	GLot	Well #	Supplemental Acres	Supplemental cf
27 S	16 E	W.M.	18 SW NW		4	1	1.42	0.02
Total Acres this Certificate							1.42	0.02

Certificate	48606	Priority	8/9/1976					
Township	Range	Mer	Sec	Q-Q	GLot	Well #	Supplemental Acres	Supplemental cf
27 S	16 E	W.M.	18 SE NE		6		10.31	0.13
Total Acres this Certificate							10.31	0.13

- LEGEND**
- SECTION LINE
  - 1/4 SECTION LINE
  - 1/16 SECTION LINE



RENEWAL 12/31/21

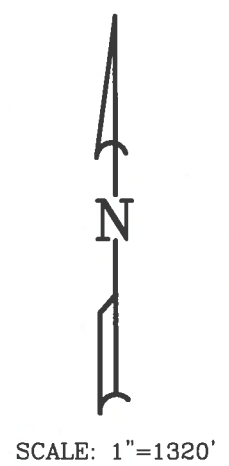

RECEIVED  
MAY 26 2020  
OWRD

NOTE:  
PREPARATION OF THIS MAP IS FOR IDENTIFYING WATER RIGHTS ONLY. IT HAS NO INTENT TO PROVIDE LOCATIONS OR DIMENSIONS OF PROPERTY BOUNDARIES.

REVISION	BY

**ANDERSON ENGINEERING AND SURVEYING, INC.**  
P.O. BOX 28  
LAKEVIEW, OREGON 97630  
(541) 947-4407  
FAX: 947-2321

FOR:  
DANIEL & LEANNE MILES  
81341 BUICK LANE  
SILVER LAKE, OR  
97638

MAP TO ACCOMPANY  
TRANSFER APPLICATION  
RESULTING LOCATIONS

DATE:	04/15/20
SCALE:	1"=1320'
DWG. BY:	R.C.
JOB:	2019-083
FILE:	2019-083
SHEET:	3 OF 4

18457 -

SECTION 2, TOWNSHIP 27 SOUTH,  
RANGE 15 EAST, W.M.

SECTION 14, TOWNSHIP 27 SOUTH,  
RANGE 15 EAST, W.M.

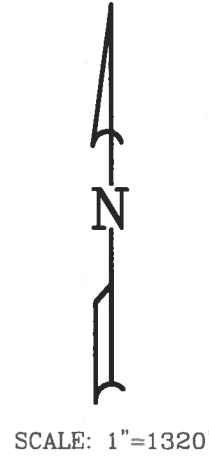
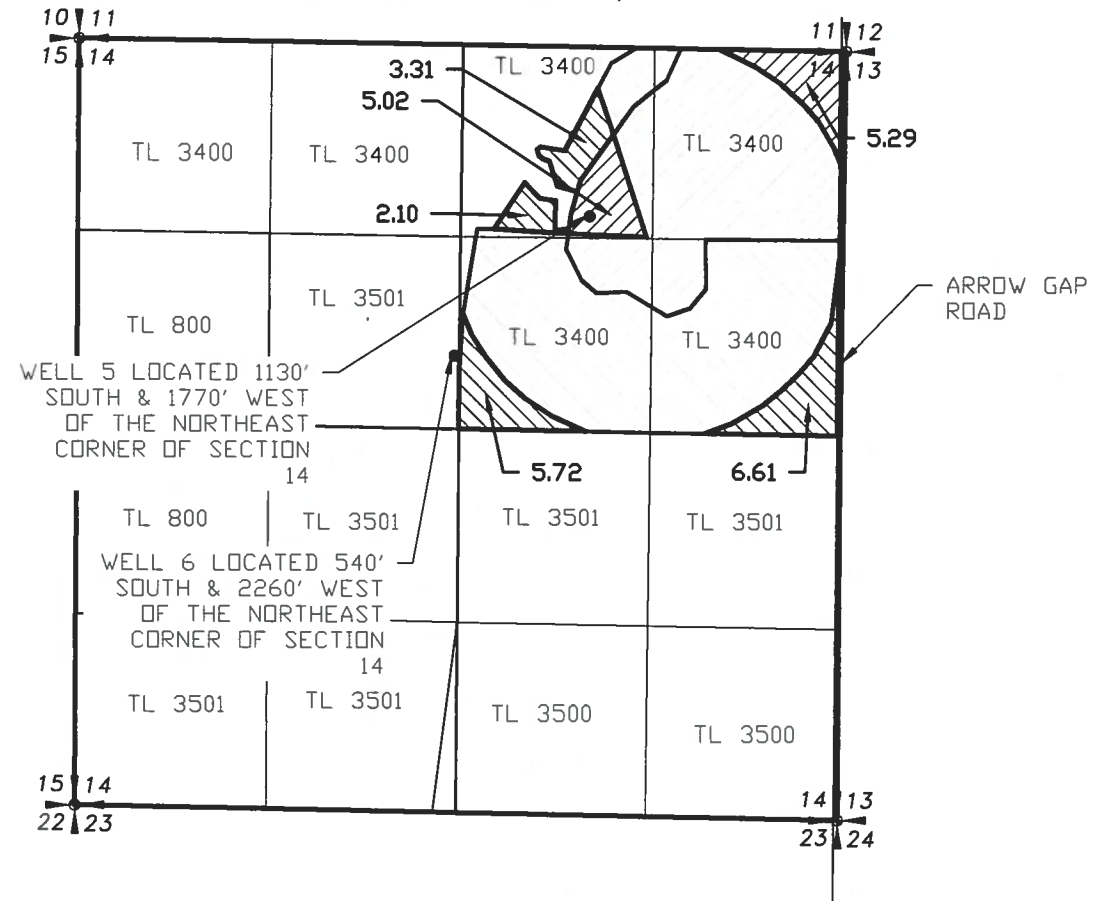
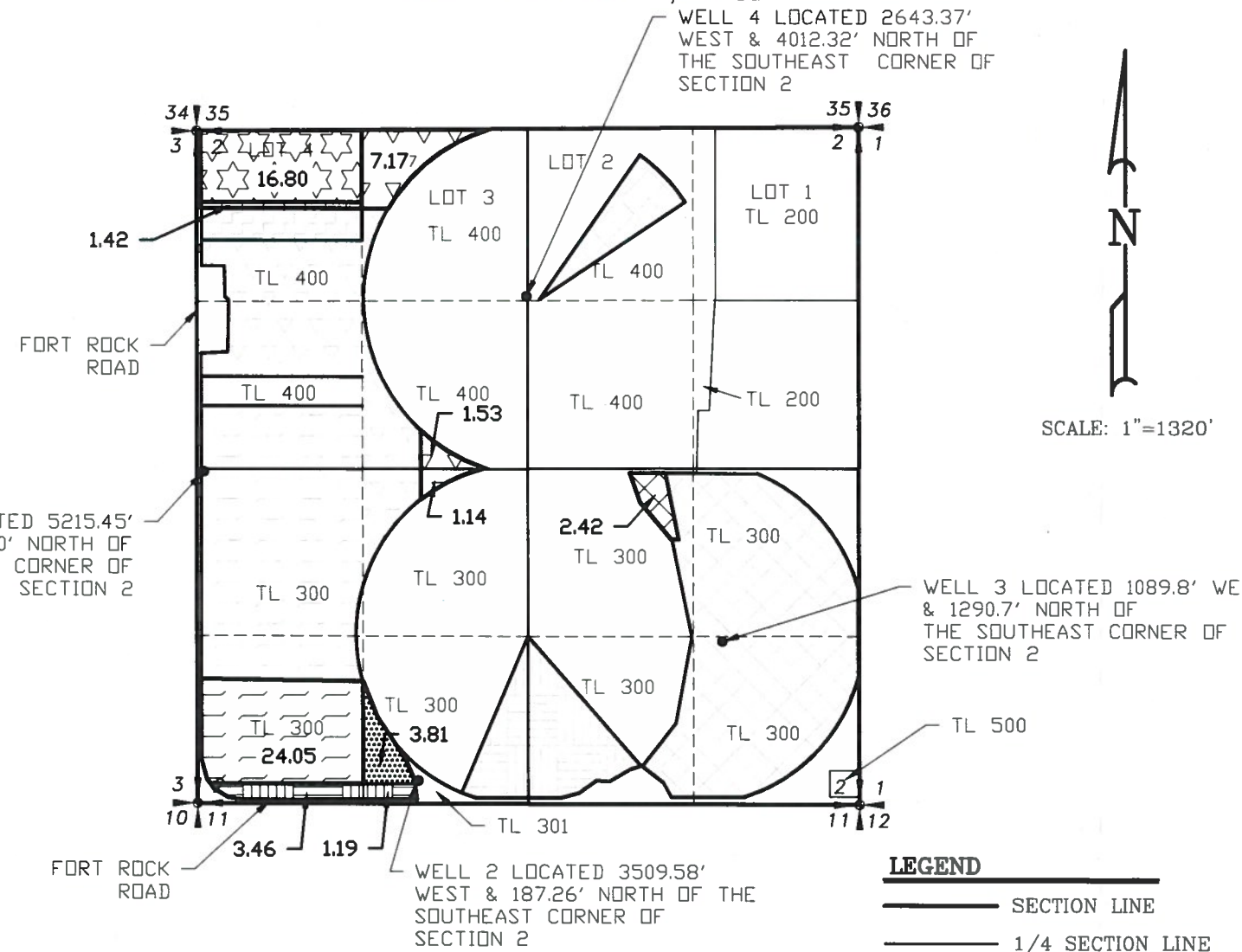

**LEGEND**

— SECTION LINE

— 1/4 SECTION LINE

- - - 1/16 SECTION LINE

Certificate	48606	Priority	8/9/1976							
Township	Range	Mer	Sec	Q-Q	GLot	Well #	Primary Acres	Supplemental Acres	Primary cfs	Supplemental cfs
27 S	15 E	WM	14	NE NE		6	0	5.29	0.00	0.0
27 S	15 E	WM	14	NW NE		6	5.41	5.02	0.07	0.04
27 S	15 E	WM	14	SW NE		6	5.72	0	0.07	0.00
27 S	15 E	WM	14	SE NE		6	6.61	0	0.00	0.00
Total Acres this Certificate							17.74	10.31	0.22	0.13
							Total cfs 0.35			



Certificate	94357	Priority	1/5/1950					
Township	Range	Mer	Sec	Q-Q	GLot	Well #	Acres	cfs
27 S	15 E	WM	2	NW SE		3	2.42	0.030
Total Acres this Certificate							2.42	0.030

Certificate	94362	Priority	4/10/1956							
Township	Range	Mer	Sec	Q-Q	GLot	Well #	Primary Acres	Supplemental Acres	Primary cfs	Supplemental cfs
27 S	15 E	WM	2	NW NW		4	1.42	0.21	0.02	0.02
Total Acres this Certificate							16.8	1.42	0.21	0.02
							Total cfs 0.23			

Certificate	94359	Priority	2/14/1974					
Township	Range	Mer	Sec	Q-Q	GLot	Well #	Acres	cfs
27 S	15 E	WM	2	SW SW		1	24.05	0.30
Total Acres this Certificate							24.05	0.30

Certificate	94361	Priority	1/17/1955					
Township	Range	Mer	Sec	Q-Q	GLot	Well #	Acres	cfs
27 S	15 E	WM	2	SW SW		2	3.46	0.04
27 S	15 E	WM	2	SE SW		2	1.19	0.01
27 S	15 E	WM	2	SE SW		1	3.81	0.05
Total Acres this Certificate							8.46	0.11

WELL 1

WELL 2

Certificate	94365	Priority	2/6/1959						
Township	Range	Mer	Sec	Q-Q	GLot	Well #	Acres	cfs	
27 S	15 E	WM	2	NENW		3	1	7.17	0.09
27 S	15 E	WM	2	NW NW		4	1	1.42	0.02
27 S	15 E	WM	2	SE NW		1	1	1.53	0.02
27 S	15 E	WM	2	NE SW		1	1	1.14	0.01
Total Acres this Certificate							11.26	0.14	

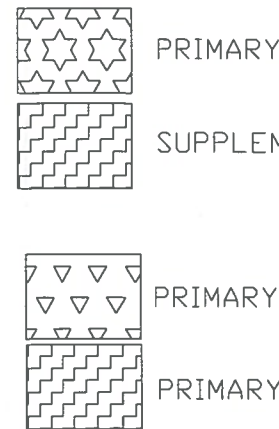

Certificate	35750	Priority	11/6/1958					
Township	Range	Mer	Sec	Q-Q	GLot	Well #	Acres	cfs
27 S	15 E	WM	14	NENE		5	5.29	0.07
27 S	15 E	WM	14	NW NE		5	5.02	0.06
Total Acres this Certificate							10.31	0.13



RECEIVED  
MAY 26 2020  
OWRD

NOTE:  
PREPARATION OF THIS MAP IS FOR IDENTIFYING WATER RIGHTS ONLY. IT HAS NO INTENT TO PROVIDE LOCATIONS OR DIMENSIONS OF PROPERTY BOUNDARIES.

REVISION	BY

**ANDERSON ENGINEERING AND SURVEYING, INC.**  
P.O. BOX 28  
LAKEVIEW, OREGON 97630  
(541) 947-4407  
FAX: 947-2321

FOR: DANIEL & LEANNE MILES  
81341 BUICK LANE  
SILVER LAKE, OR 97638

MAP TO ACCOMPANY  
TRANSFER APPLICATION  
AREAS TO TRANSFER

DATE:	04/15/20
SCALE:	1"=1320'
DWG. BY:	R.C.
JOB:	2019-083
FILE:	2019-083
SHEET:	2 OF 4

SECTION 2, TOWNSHIP 27 SOUTH,  
RANGE 15 EAST, W.M.

SECTION 14, TOWNSHIP 27 SOUTH,  
RANGE 15 EAST, W.M.

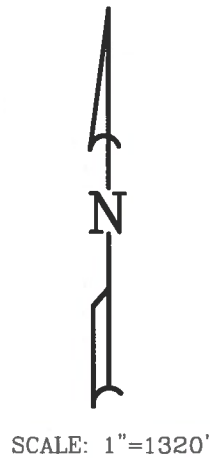
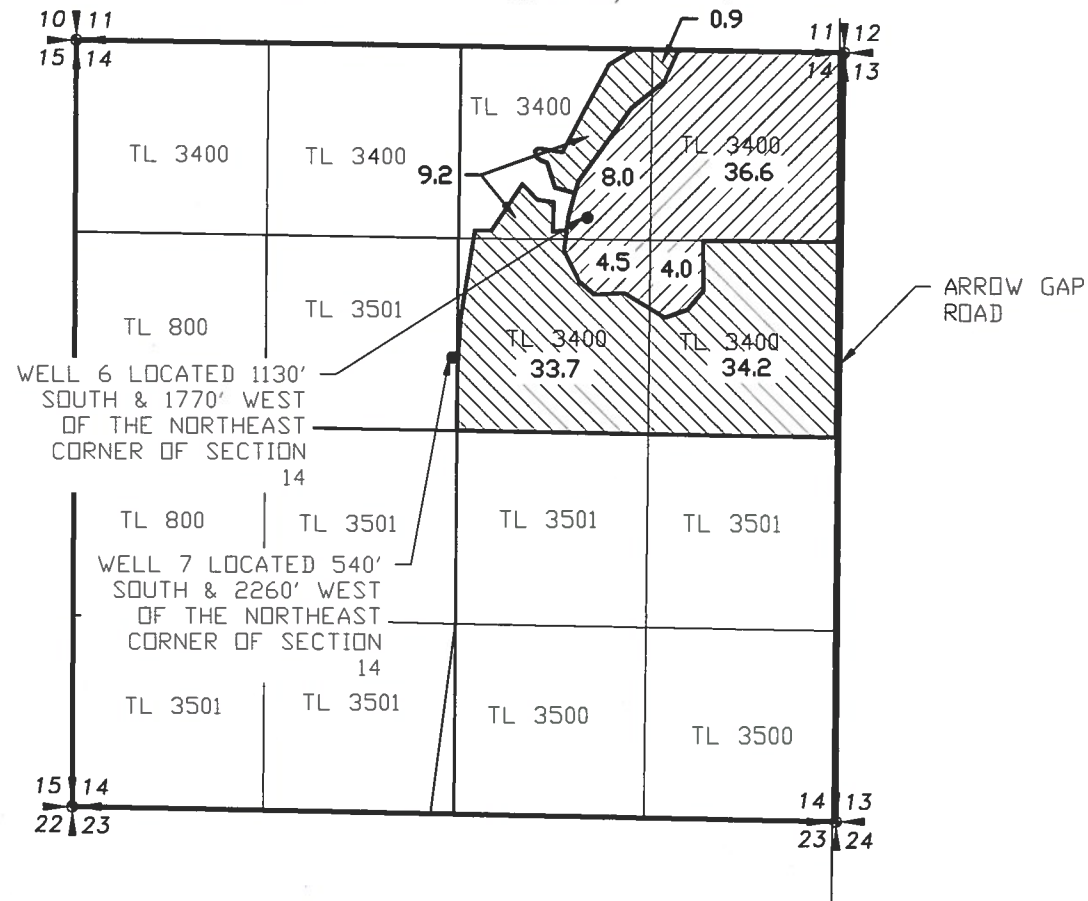
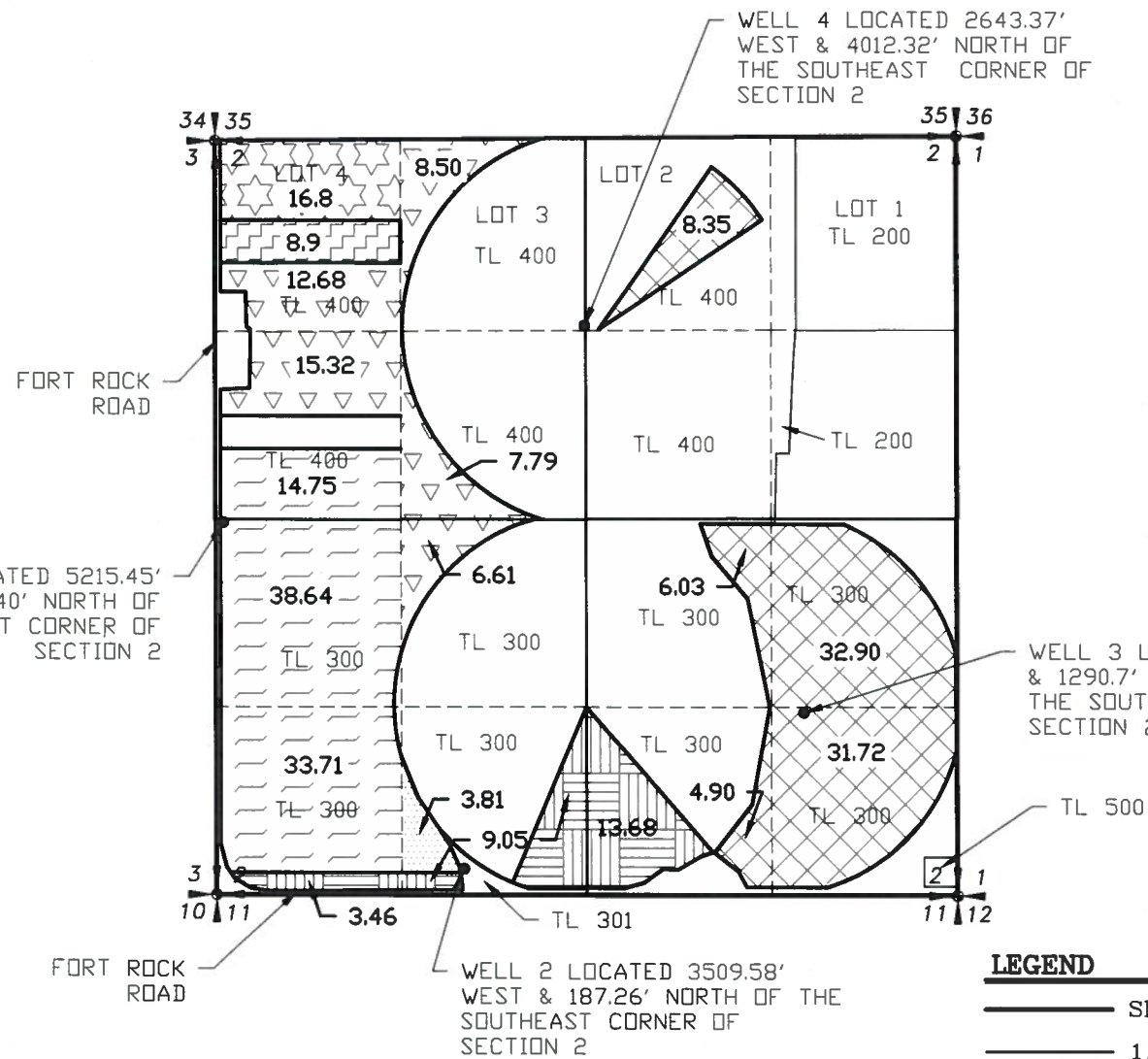

**LEGEND**  
 — SECTION LINE  
 — 1/4 SECTION LINE  
 - - - 1/16 SECTION LINE

Certificate	48606	Priority	8/9/1976	Primary Acres	Supplemental Acres	Primary cfs	Supplemental cfs
Township	Range	Mer	Sec	Q-Q	GLot	Well #	
27 S	15 E	WM	14	NENE	6	0.9	36.6
27 S	15 E	WM	14	NW NE	6	9.2	8
27 S	15 E	WM	14	SW NE	6	33.7	4.5
27 S	15 E	WM	14	SE NE	6	34.2	4
Total Acres this Certificate				78	53.1	0.98	0.66
				Total cfs		1.64	



Certificate	94357	Priority	1/5/1950	Primary Acres	Supplemental Acres	Primary cfs	Supplemental cfs
Township	Range	Mer	Sec	Q-Q	GLot	Well #	
27 S	15 E	WM	2	NW NE	2	4	83.5
27 S	15 E	WM	2	NE SE	3	3	32.9
27 S	15 E	WM	2	NW SE	3	6.03	0.075
27 S	15 E	WM	2	SW SE	3	4.9	0.061
27 S	15 E	WM	2	SE SE	3	31.72	0.397
Total Acres this Certificate				83.9	1.049		

Certificate	94362	Priority	4/10/1956	Primary Acres	Supplemental Acres	Primary cfs	Supplemental cfs
Township	Range	Mer	Sec	Q-Q	GLot	Well #	
27 S	15 E	WM	2	NW NW	4	1	16.8
Total Acres this Certificate				16.8	8.9	0.21	0.11
				Total cfs		0.32	

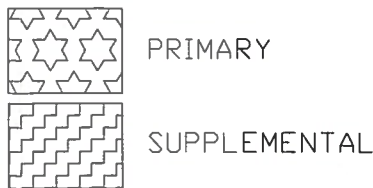

Certificate	94359	Priority	2/14/1974	Primary Acres	Supplemental Acres	Primary cfs	Supplemental cfs
Township	Range	Mer	Sec	Q-Q	GLot	Well #	
27 S	15 E	WM	2	SW NW	1	1	14.75
27 S	15 E	WM	2	NW SW	1	1	38.64
27 S	15 E	WM	2	SW SW	1	1	33.71
Total Acres this Certificate				87.1	1.09		

Certificate	94361	Priority	1/17/1955	Primary Acres	Supplemental Acres	Primary cfs	Supplemental cfs
Township	Range	Mer	Sec	Q-Q	GLot	Well #	
27 S	15 E	WM	2	SW SW	2	2	3.46
27 S	15 E	WM	2	SE SW	2	2	9.05
27 S	15 E	WM	2	SE SW	1	1	3.81
27 S	15 E	WM	2	SE SW	2	2	13.68
Total Acres this Certificate				30	0.38		

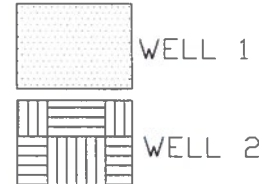

Certificate	94365	Priority	2/6/1959	Primary Acres	Supplemental Acres	Primary cfs	Supplemental cfs
Township	Range	Mer	Sec	Q-Q	GLot	Well #	
27 S	15 E	WM	2	NENW	3	1	8.5
27 S	15 E	WM	2	NW NW	4	1	21.58
27 S	15 E	WM	2	SW NW	1	1	15.32
27 S	15 E	WM	2	SE NW	1	1	7.79
27 S	15 E	WM	2	NE SW	1	1	6.61
Total Acres this Certificate				59.8	0.75		

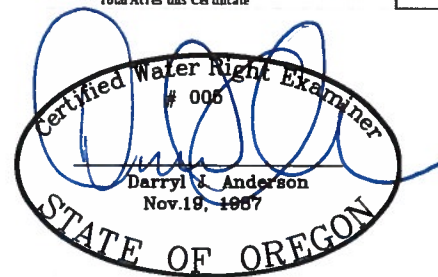
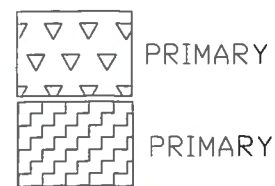

RENEWAL 12/31/21

RECEIVED  
MAY 26 2020

OWRD

NOTE: PREPARATION OF THIS MAP IS FOR IDENTIFYING WATER RIGHTS ONLY. IT HAS NO INTENT TO PROVIDE LOCATIONS OR DIMENSIONS OF PROPERTY BOUNDARIES.

REVISION	BY

**ANDERSON ENGINEERING AND SURVEYING, INC.**  
 P.O. BOX 28  
 LAKEVIEW, OREGON 97630  
 (541) 947-4407  
 FAX: 947-2321

FOR: DANIEL & LEANNE MILES  
 81341 BUICK LANE  
 SILVER LAKE, OR 97638

MAP TO ACCOMPANY  
 TRANSFER APPLICATION  
 ORIGINAL CERTIFICATE LAYOUTS

DATE:	04/15/20
SCALE:	1"=1320'
DWG. BY:	R.C.
JOB:	2019-083
FILE:	2019-083
SHEET:	1 OF 4

CERTIFICATE 94365

SECTION 2, TOWNSHIP 27 SOUTH,  
RANGE 15 EAST, W.M.

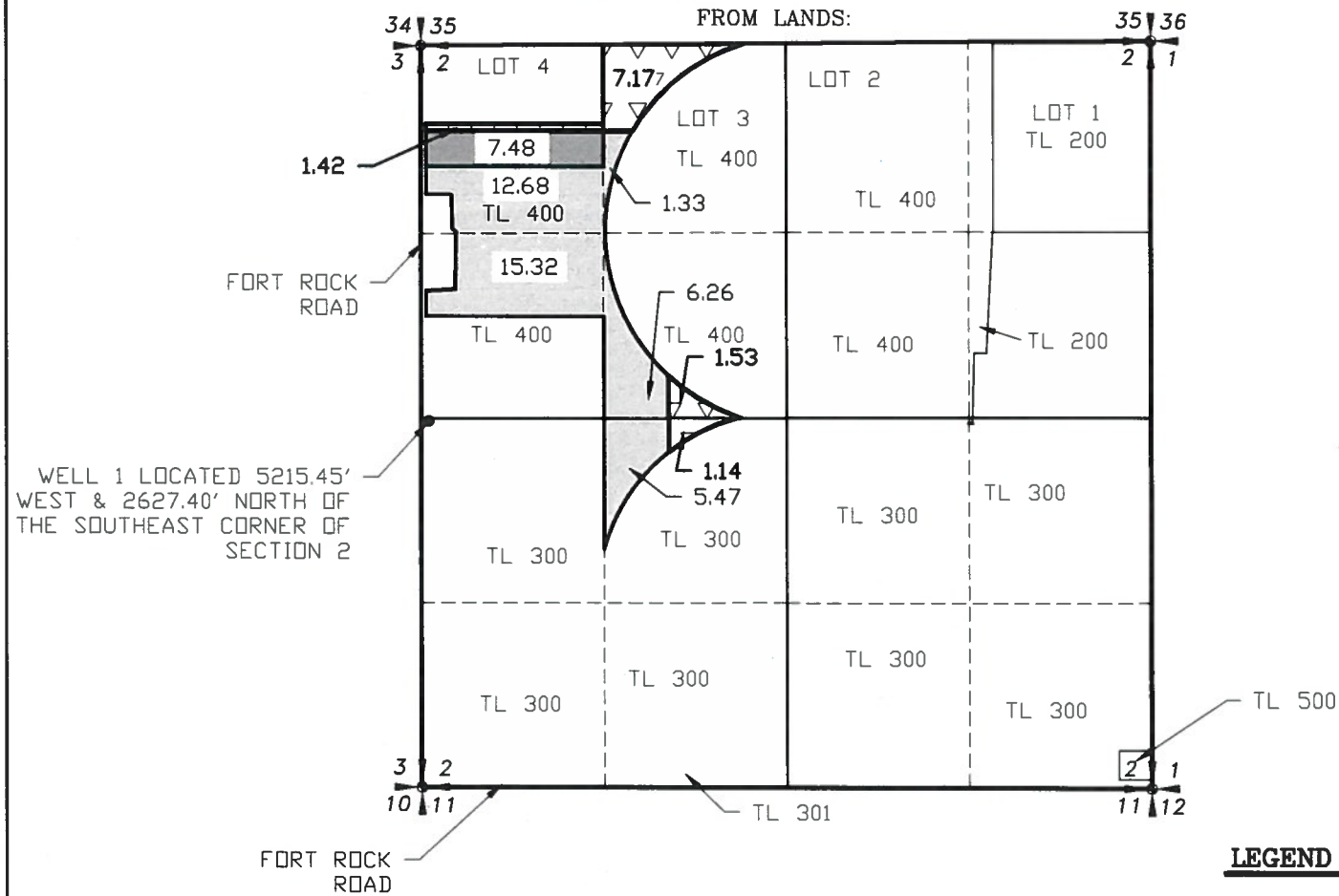

SECTION 18, TOWNSHIP 27 SOUTH,  
RANGE 16 EAST, W.M.

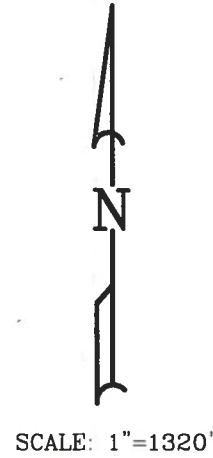
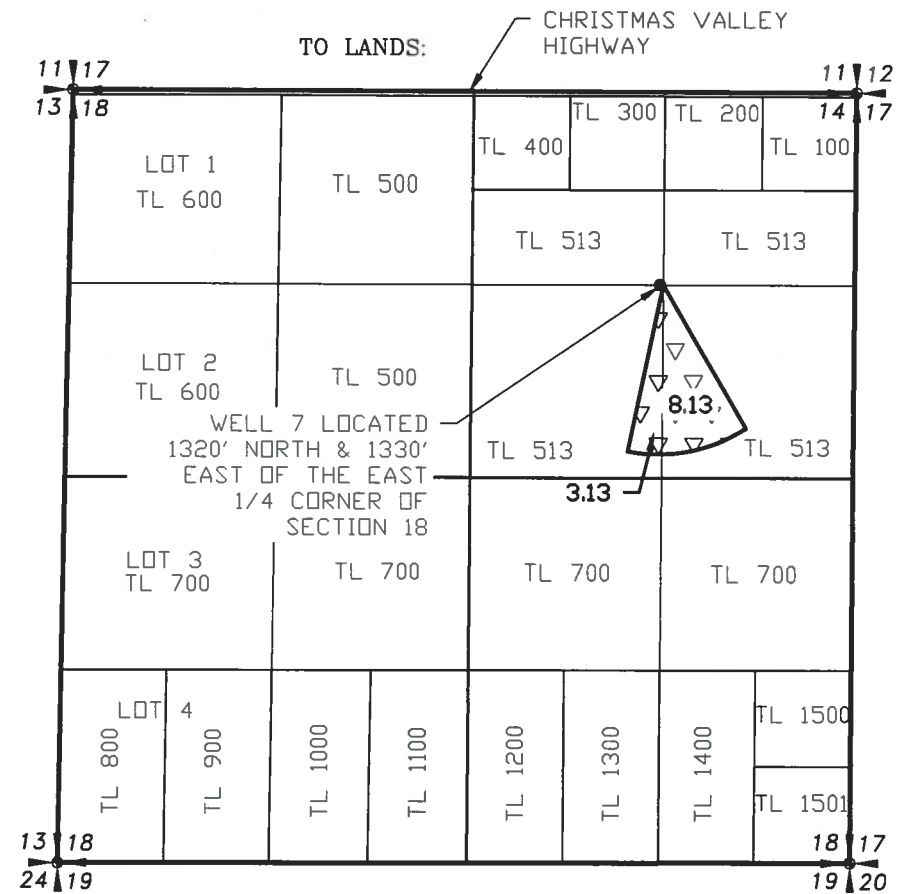

- LEGEND**
- SECTION LINE
  - 1/4 SECTION LINE
  - - - 1/16 SECTION LINE

TO TRANSFER:

Certificate		94365		Priority		2/6/1959			
Township	Range	Mer	Sec	Q-Q	GLot	Well #	Acres	cfs	
27 S	15 E	W.M.	2	NE NW	3	1	7.17	0.09	▽▽▽▽
27 S	15 E	W.M.	2	NW NW	4	1	1.42	0.02	▽▽▽▽
27 S	15 E	W.M.	2	SE NW		1	1.53	0.02	▽▽▽▽
27 S	15 E	W.M.	2	NE SW		1	1.14	0.01	▽▽▽▽
Total Acres this Certificate							11.26	0.14	

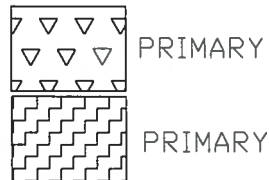

TO REMAIN:

Certificate		94365		Priority		2/6/1959			
Township	Range	Mer	Sec	Q-Q	GLot	Well #	Acres	cfs	
27 S	15 E	W.M.	2	NE NW	3	1	1.33	0.02	□
27 S	15 E	W.M.	2	NW NW	4	1	20.16	0.25	□
27 S	15 E	W.M.	2	SW NW		1	15.32	0.19	□
27 S	15 E	W.M.	2	SE NW		1	6.26	0.08	□
27 S	15 E	W.M.	2	NE SW		1	5.47	0.07	□
Total Acres this Certificate							48.54	0.61	

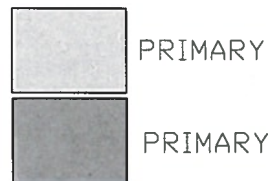

NEW LOCATION:

Certificate		94365		Priority		2/6/1959			
Township	Range	Mer	Sec	Q-Q	GLot	Well #	Acres	cfs	
27 S	16 E	W.M.	18	SW NE		7	8.13	0.10	▽▽▽▽
27 S	16 E	W.M.	18	SE NE		7	3.13	0.04	▽▽▽▽
Total Acres this Certificate							11.26	0.14	

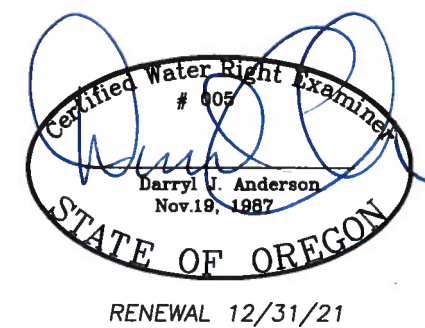
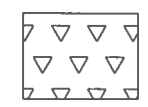

RECEIVED  
MAY 26 2020  
OWRD

NOTE:  
PREPARATION OF THIS MAP IS FOR IDENTIFYING WATER RIGHTS ONLY. IT HAS NO INTENT TO PROVIDE LOCATIONS OR DIMENSIONS OF PROPERTY BOUNDARIES.

REVISION	BY

**ANDERSON ENGINEERING AND SURVEYING, INC.**  
P.O. BOX 28  
LAKEVIEW, OREGON 97630  
(541) 947-4407  
FAX: 947-2321

FOR:  
DANIEL & LEANNE MILES  
81341 BUCK LANE  
SILVER LAKE, OR  
97638

MAP TO ACCOMPANY  
TRANSFER APPLICATION  
CERTIFICATE 94365

DATE:	04/15/20
SCALE:	1"=1320'
DWG. BY:	R.C.
JOB:	2019-083
FILE:	2019-083
SHEET:	1 OF 1

CERTIFICATE 94362

SECTION 2, TOWNSHIP 27 SOUTH,  
RANGE 15 EAST, W.M.

SECTION 18, TOWNSHIP 27 SOUTH,  
RANGE 16 EAST, W.M.

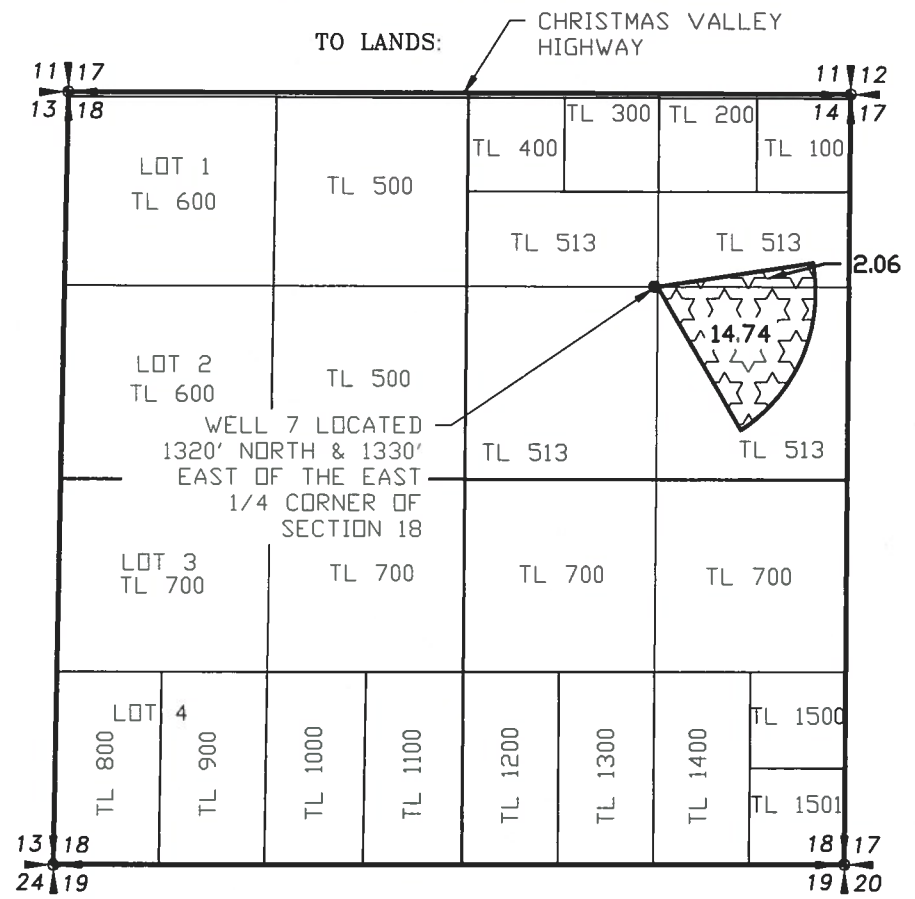
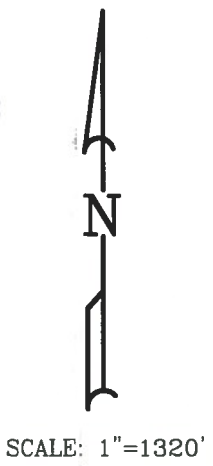
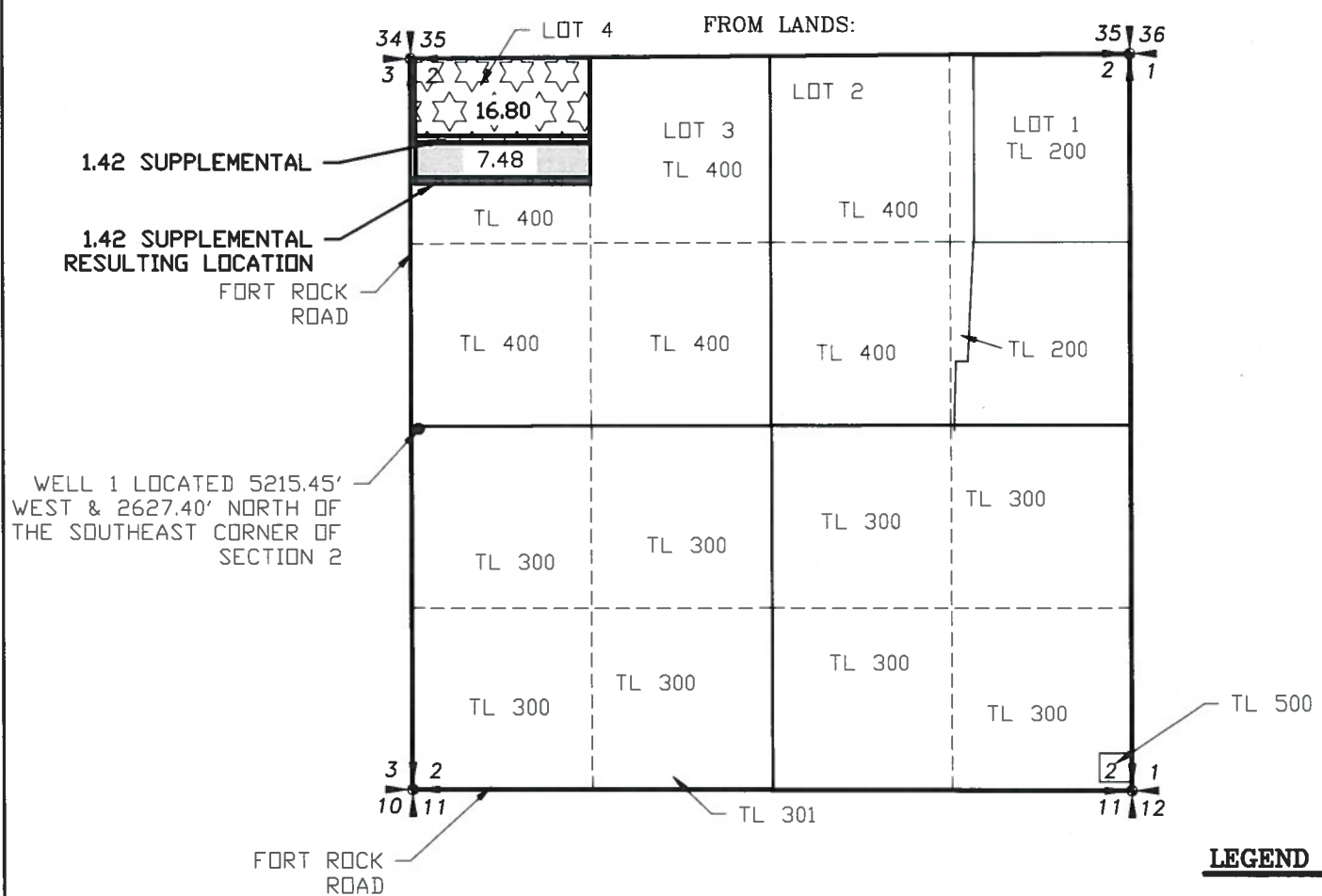

**LEGEND**  
 — SECTION LINE  
 — 1/4 SECTION LINE  
 - - - 1/16 SECTION LINE

TO TRANSFER:

Certificate		94362		Priority		4/10/1956					
Township	Range	Mer	Sec	Q-Q	GLot	Well #	Primary Acres	Supplemental Acres	Primary cfs	Supplemental cfs	Total cfs
27 S	15 E	WM	2	NW-NW	4	1	16.8	1.42	0.21	0.02	0.23
Total Acres this Certificate							16.8	1.42	0.21	0.02	0.23



TO REMAIN:

Certificate		94362		Priority		4/10/1956					
Township	Range	Mer	Sec	Q-Q	GLot	Well #	Primary Acres	Supplemental Acres	Primary cfs	Supplemental cfs	Total cfs
27 S	15 E	WM	2	NW-NW	4	1	0	7.48	0.00	0.00	0.00
Total Acres this Certificate							0	7.48	0.00	0.00	0.00



NEW LOCATION:

Certificate		94362		Priority		4/10/1956					
Township	Range	Mer	Sec	Q-Q	GLot	Well #	Primary Acres	Supplemental Acres	Primary cfs	Supplemental cfs	Total cfs
27 S	16 E	WM	18	NE-NE		7	2.06		0.03		0.03
27 S	16 E	WM	18	SE-NE		7	14.74		0.18		0.18
Total Acres this Certificate							16.8		0.21		0.21



Certificate		94362		Priority		4/10/1956					
Township	Range	Mer	Sec	Q-Q	GLot	Well #	Supplemental Acres	Supplemental cfs	Primary Acres	Primary cfs	Total cfs
27 S	15 E	WM	2	NW-NW	4	1	1.42	0.02			0.02
Total Acres this Certificate							1.42	0.02			0.02

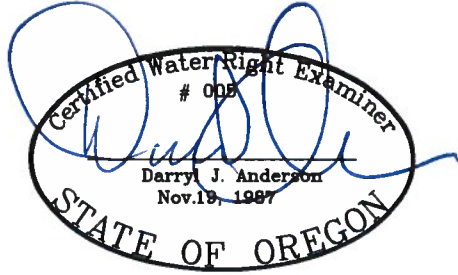

RENEWAL 12/31/21

**RECEIVED**  
MAY 26 2020

**OWRD**

NOTE: PREPARATION OF THIS MAP IS FOR IDENTIFYING WATER RIGHTS ONLY. IT HAS NO INTENT TO PROVIDE LOCATIONS OR DIMENSIONS OF PROPERTY BOUNDARIES.

REVISION	BY

**ANDERSON ENGINEERING AND SURVEYING, INC.**  
 P.O. BOX 28  
 LAKEVIEW, OREGON 97630  
 (541) 947-4407  
 FAX: 947-2321

FOR: DANIEL & LEANNE MILES  
 81341 BUICK LANE  
 SILVER LAKE, OR 97638

MAP TO ACCOMPANY  
 TRANSFER APPLICATION  
 CERTIFICATE 94362

DATE:	04/15/20
SCALE:	1"=1320'
DWG. BY:	R.C.
JOB:	2019-083
FILE:	2019-083
SHEET:	1 OF 1

CERTIFICATE 94361

SECTION 2, TOWNSHIP 27 SOUTH,  
RANGE 15 EAST, W.M.

SECTION 18, TOWNSHIP 27 SOUTH,  
RANGE 16 EAST, W.M.

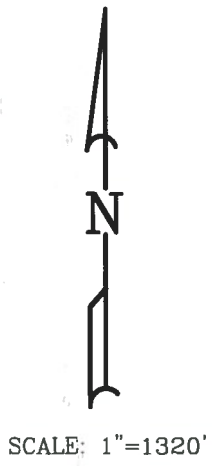
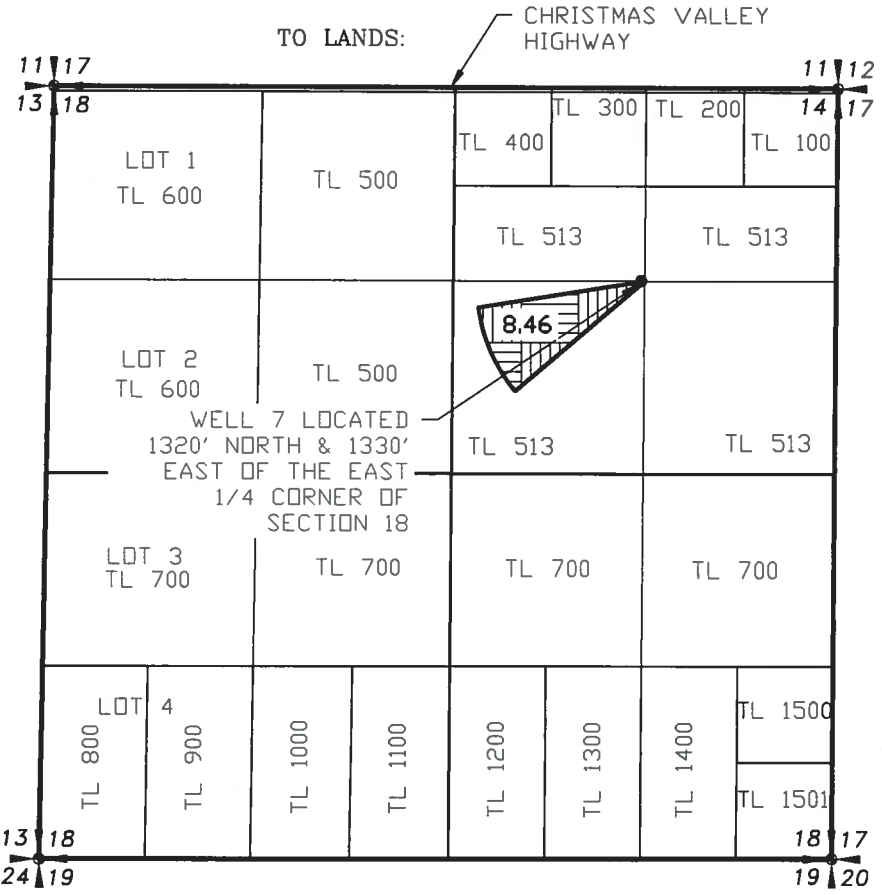
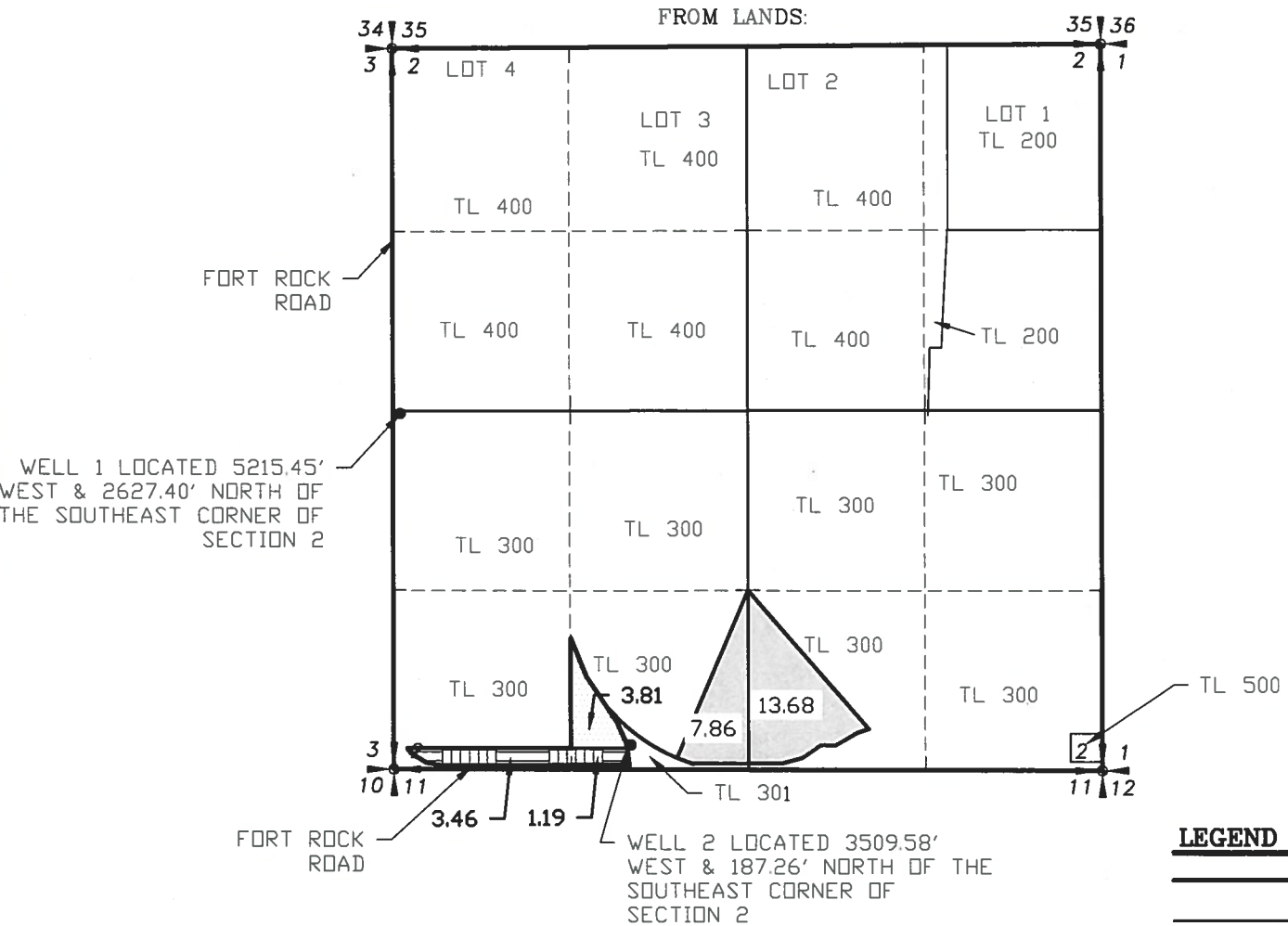

**LEGEND**

— SECTION LINE

— 1/4 SECTION LINE

--- 1/16 SECTION LINE

NEW LOCATION:

Certificate	94361	Priority	1/17/1955					
Township	Range	Mer	Sec	Q-Q	GLot	Well #	Acres	cfs
27 S	16 E	WM	18	SW-NE		7	8.46	0.11
Total Acres this Certificate							8.46	0.11

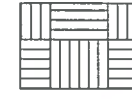

TO TRANSFER:

Certificate	94361	Priority	1/17/1955					
Township	Range	Mer	Sec	Q-Q	GLot	Well #	Acres	cfs
27 S	15 E	WM	2	SW-SW		2	3.46	0.04
27 S	15 E	WM	2	SE-SW		2	1.19	0.01
27 S	15 E	WM	2	SE-SW		1	3.81	0.05
Total Acres this Certificate							8.46	0.11

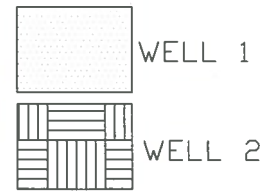

TO REMAIN:

Certificate	94361	Priority	1/17/1955					
Township	Range	Mer	Sec	Q-Q	GLot	Well #	Acres	cfs
27 S	15 E	WM	2	SE-SW		2	7.86	0.10
27 S	15 E	WM	2	SW-SE		2	13.68	0.17
Total Acres this Certificate							21.54	0.27



Certified Water Right Examiner  
# 005  
Darryl J. Anderson  
Nov. 18, 1987  
STATE OF OREGON

RENEWAL 12/31/21

RECEIVED  
MAY 26 2020  
OWRD

NOTE:  
PREPARATION OF THIS MAP IS FOR IDENTIFYING WATER RIGHTS ONLY. IT HAS NO INTENT TO PROVIDE LOCATIONS OR DIMENSIONS OF PROPERTY BOUNDARIES.

REVISION	BY

ANDERSON ENGINEERING AND SURVEYING, INC.  
P.O. BOX 28  
LAKEVIEW, OREGON 97630  
(541) 947-4407  
FAX: 947-2321

FOR: DANIEL & LEANNE MILES  
81341 BUICK LANE  
SILVER LAKE, OR 97638

MAP TO ACCOMPANY  
TRANSFER APPLICATION  
CERTIFICATE 94361

DATE:	04/15/20
SCALE:	1"=1320'
DWG. BY:	R.C.
JOB:	2019-083
FILE:	2019-083
SHEET:	1 OF 1

CERTIFICATE 94359

SECTION 2, TOWNSHIP 27 SOUTH,  
RANGE 15 EAST, W.M.

SECTION 18, TOWNSHIP 27 SOUTH,  
RANGE 16 EAST, W.M.

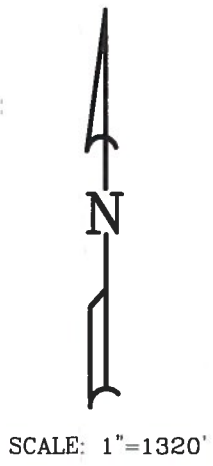
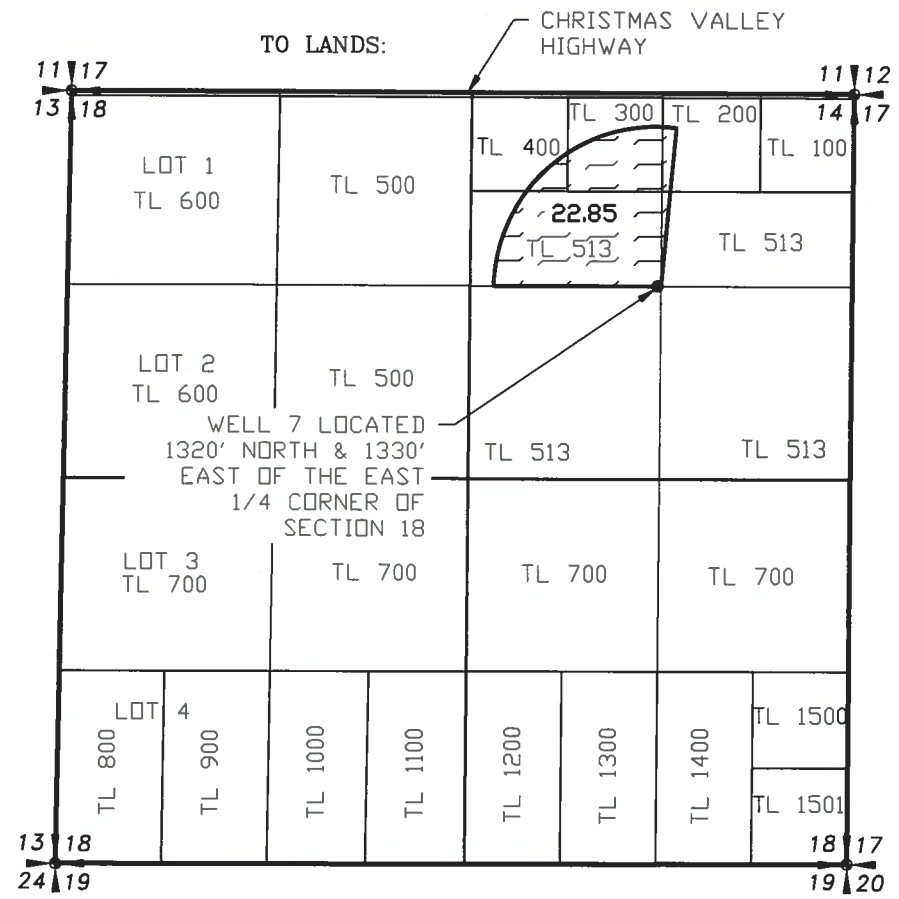
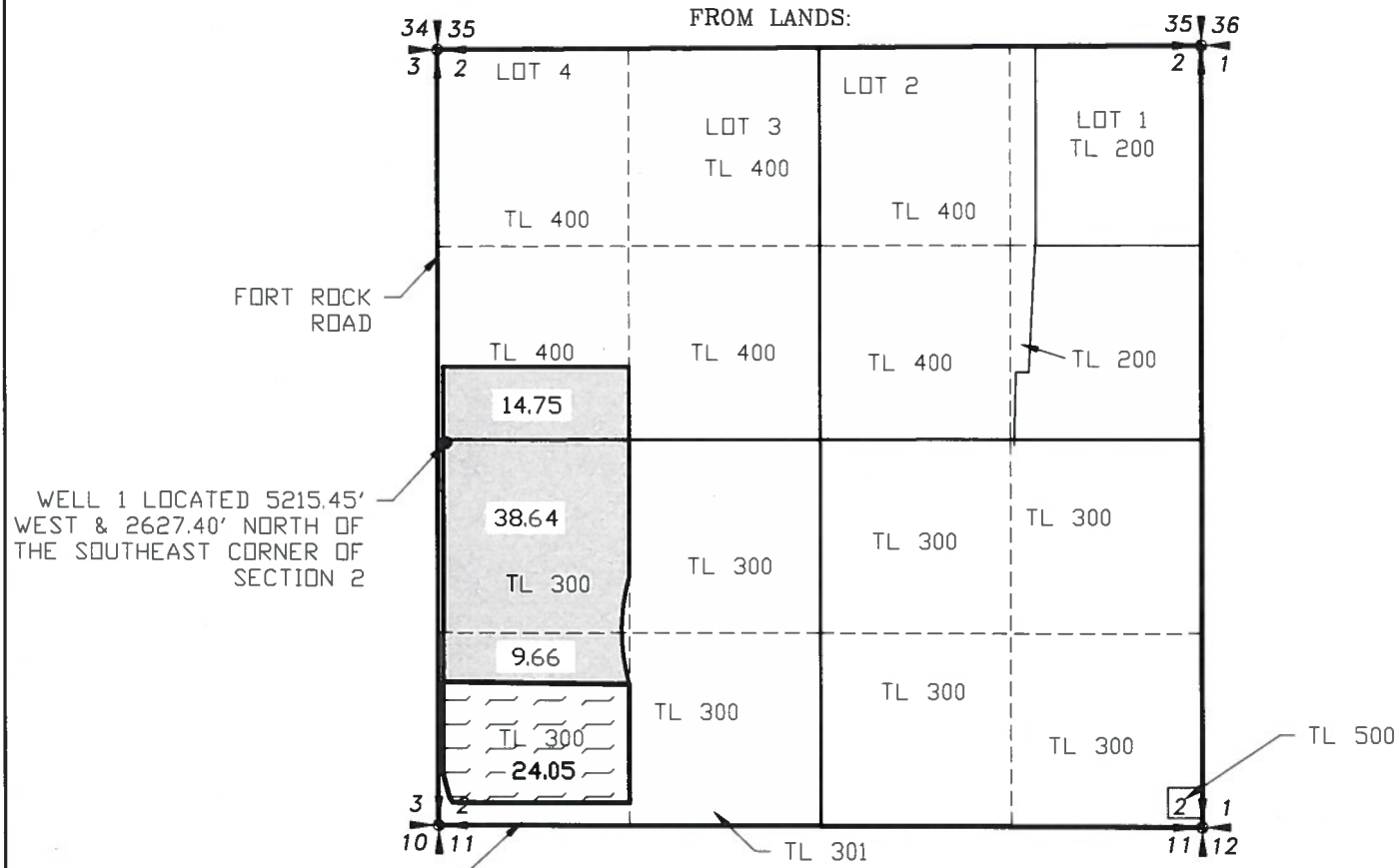

**LEGEND**  
 — SECTION LINE  
 - - - 1/4 SECTION LINE  
 . . . . . 1/16 SECTION LINE

TO TRANSFER:

Certificate	94359	Priority	2/14/1974					
Township	Range	Mer	Sec	Q-Q	GLot	Well#	Acres	cb
27 S	15 E	WM	2 SW SW			1	24.05	0.30
Total Acres this Certificate							24.05	0.30

TO REMAIN:

Certificate	94359	Priority	2/14/1974					
Township	Range	Mer	Sec	Q-Q	GLot	Well#	Acres	cb
27 S	15 E	WM	2 SW NW			1	14.75	0.18
27 S	15 E	WM	2 NW SW			1	38.64	0.48
27 S	15 E	WM	2 SW SW			1	9.66	0.12
Total Acres this Certificate							63.05	0.79

NEW LOCATION:

Certificate	94359	Priority	2/14/1974					
Township	Range	Mer	Sec	Q-Q	GLot	Well#	Acres	cb
27 S	16 E	WM	18 NENE			7	12	0.02
27 S	16 E	WM	18 NWNE			7	22.85	0.29
Total Acres this Certificate							24.05	0.30

**RECEIVED**  
**MAY 26 2020**  
**OWRD**

*Darryl J. Anderson*  
 Darryl J. Anderson  
 Nov 19, 1987  
 STATE OF OREGON  
 RENEWAL 12/31/21

NOTE:  
 PREPARATION OF THIS MAP IS FOR IDENTIFYING WATER RIGHTS ONLY. IT HAS NO INTENT TO PROVIDE LOCATIONS OR DIMENSIONS OF PROPERTY BOUNDARIES.

REVISION	BY

**ANDERSON ENGINEERING AND SURVEYING, INC.**  
 P.O. BOX 28  
 LAKEVIEW, OREGON 97630  
 (541) 947-4407  
 FAX: 947-2321

FOR: DANIEL & LEANNE MILES  
 81341 BUICK LANE  
 SILVER LAKE, OR 97638

**MAP TO ACCOMPANY**  
**TRANSFER APPLICATION**  
**CERTIFICATE 94359**

DATE:	04/15/20
SCALE:	1"=1320'
DWG. BY:	R.C.
JOB:	2019-083
FILE:	2019-083
SHEET:	1 OF 1

CERTIFICATE 94357

SECTION 2, TOWNSHIP 27 SOUTH,  
RANGE 15 EAST, W.M.

SECTION 18, TOWNSHIP 27 SOUTH,  
RANGE 16 EAST, W.M.

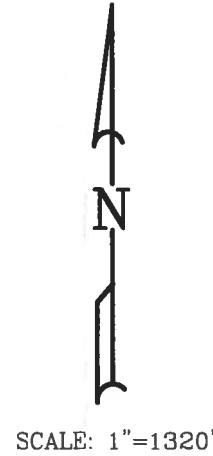
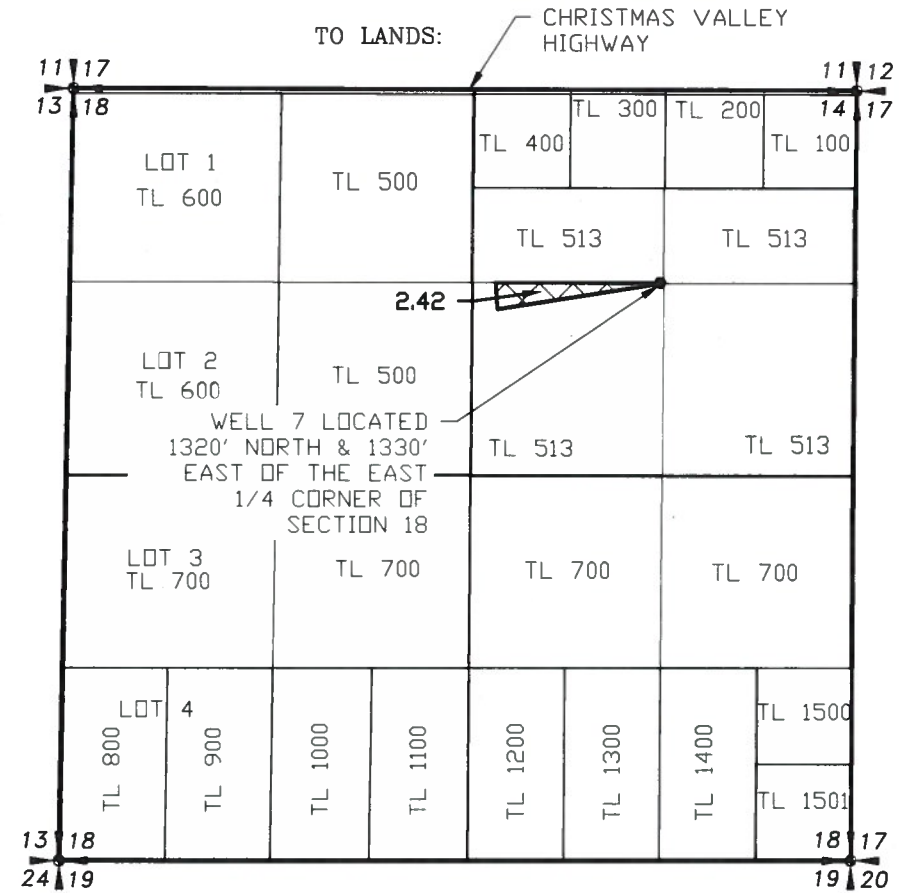
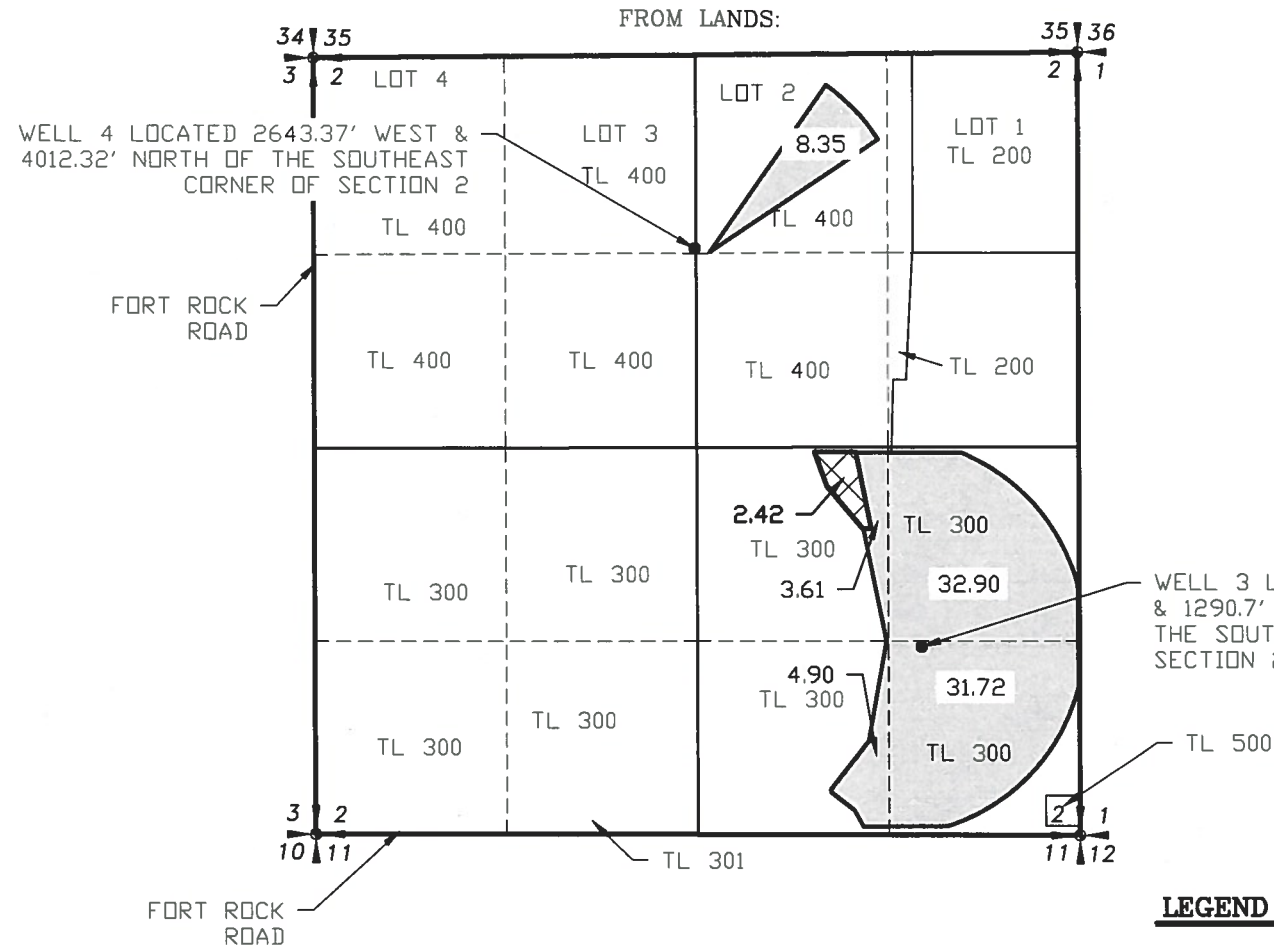

- LEGEND**
- SECTION LINE
  - 1/4 SECTION LINE
  - - - - 1/16 SECTION LINE

NEW LOCATION:

Certificate	94357	Priority	1/5/1950					
Township	Range	Mer	Sec	Q-Q	GLot	Well #	Acres	cfs
27 S	16 E	WM	18	SW NE		7	2.42	0.03
27 S	16 E	WM	18	SE NE		7	0	0.00
Total Acres this Certificate							2.42	0.030



TO TRANSFER:

Certificate	94357	Priority	1/5/1950					
Township	Range	Mer	Sec	Q-Q	GLot	Well #	Acres	cfs
27 S	15 E	WM	2	NW SE		3	2.42	0.030
Total Acres this Certificate							2.42	0.030



TO REMAIN:

Certificate	94357	Priority	1/5/1950					
Township	Range	Mer	Sec	Q-Q	GLot	Well #	Acres	cfs
27 S	15 E	WM	2	NW NE		4	8.35	0.104
27 S	15 E	WM	2	NE SE		3	32.9	0.411
27 S	15 E	WM	2	NW SE		3	3.61	0.045
27 S	15 E	WM	2	SW SE		3	4.9	0.061
27 S	15 E	WM	2	SE SE		3	31.72	0.397
Total Acres this Certificate							81.48	1.019

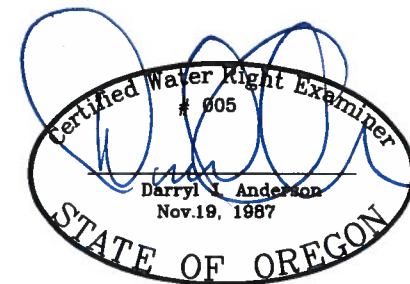

RENEWAL 12/31/21

RECEIVED

MAY 26 2020

OWRD

NOTE:  
PREPARATION OF THIS MAP IS FOR IDENTIFYING WATER RIGHTS ONLY. IT HAS NO INTENT TO PROVIDE LOCATIONS OR DIMENSIONS OF PROPERTY BOUNDARIES.

REVISION	BY

**ANDERSON ENGINEERING AND SURVEYING, INC.**  
P.O. BOX 28  
LAKEVIEW, OREGON 97630  
(541) 947-4407  
FAX: 947-2321

FOR:  
DANIEL & LEANNE MILES  
81341 BUICK LANE  
SILVER LAKE, OR  
97638

MAP TO ACCOMPANY  
TRANSFER APPLICATION  
CERTIFICATE 94357

DATE:	04/15/20
SCALE:	1"=1320'
DWG. BY:	R.C.
JOB:	2019-083
FILE:	2019-083
SHEET:	1 OF 1



CERTIFICATE 48606

SECTION 14, TOWNSHIP 27 SOUTH,  
RANGE 15 EAST, W.M.

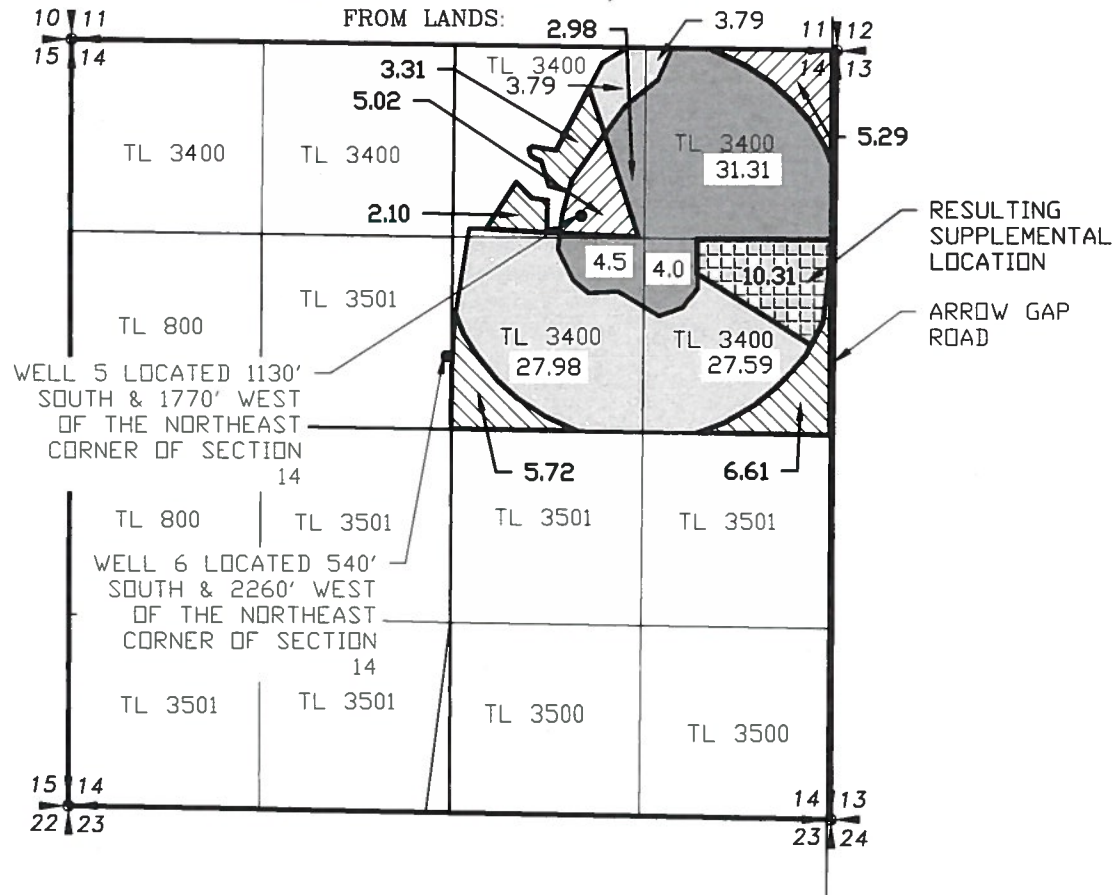

SECTION 18, TOWNSHIP 27 SOUTH,  
RANGE 16 EAST, W.M.

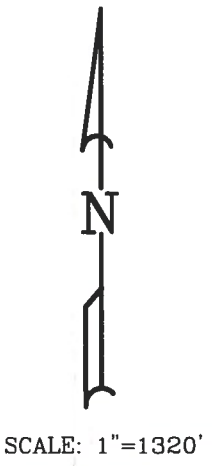
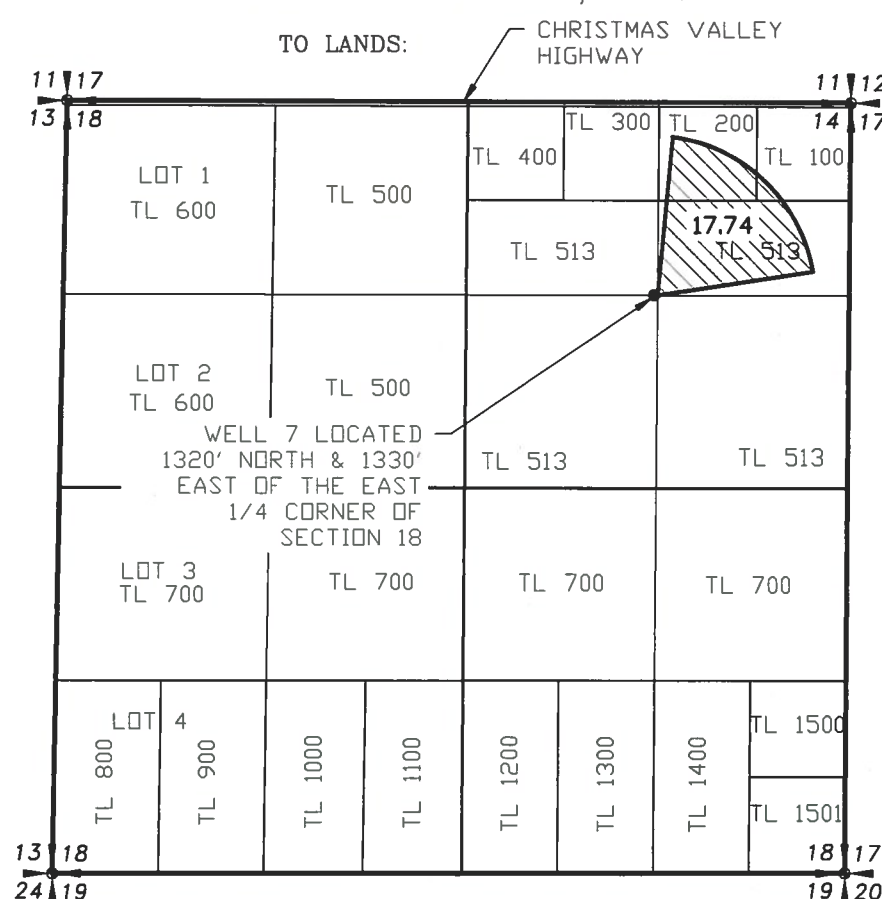

**LEGEND**  
 — SECTION LINE  
 — 1/4 SECTION LINE  
 - - - 1/16 SECTION LINE

TO TRANSFER:

Certificate	48606	Priority		8/9/1976							
		Range	Mer	Sec	Q-Q	GLot	Well #	Primary Acres	Supplemental Acres	Primary cfs	Supplemental cfs
27 S	15 E	WM	14	NE NE		6	0	5.29	0.00	0.07	
27 S	15 E	WM	14	NW NE		6	3.41	5.02	0.07	0.06	
27 S	15 E	WM	14	SW NE		6	5.72	0	0.07	0.00	
27 S	15 E	WM	14	SE NE		6	6.61	0	0.08	0.00	
Total Acres this Certificate							17.74	10.31	0.22	0.13	
											0.35



TO REMAIN:

Certificate	48606	Priority		8/9/1976							
		Range	Mer	Sec	Q-Q	GLot	Well #	Primary Acres	Supplemental Acres	Primary cfs	Supplemental cfs
27 S	15 E	WM	14	NE NE		6	0.9	31.31	0.01	0.39	
27 S	15 E	WM	14	NW NE		6	3.79	2.98	0.05	0.04	
27 S	15 E	WM	14	SW NE		6	27.98	4.5	0.35	0.06	
27 S	15 E	WM	14	SE NE		6	27.59	4	0.34	0.05	
Total Acres this Certificate							60.26	42.79	0.75	0.53	
											1.29



NEW LOCATION:

Certificate	48606	Priority		8/9/1976						
		Range	Mer	Sec	Q-Q	GLot	Well #	Primary Acres	Primary cfs	
27 S	16 E	WM	18	NE NE		7	17.74	0.22		
Total Acres this Certificate							17.74	0.22		



Certificate	48606	Priority		8/9/1976						
		Range	Mer	Sec	Q-Q	GLot	Well #	Supplemental Acres	Supplemental cfs	
27 S	15 E	WM	14	SE NE		6	10.31	0.13		
Total Acres this Certificate							10.31	0.13		



**RECEIVED**  
 MAY 26 2020  
**OWRD**

NOTE: PREPARATION OF THIS MAP IS FOR IDENTIFYING WATER RIGHTS ONLY. IT HAS NO INTENT TO PROVIDE LOCATIONS OR DIMENSIONS OF PROPERTY BOUNDARIES.

REVISION	BY

**ANDERSON ENGINEERING AND SURVEYING, INC.**  
 P.O. BOX 28  
 LAKEVIEW, OREGON 97630  
 (541) 947-4407  
 FAX: 947-2321

FOR: DANIEL & LEANNE MILES  
 81341 BUICK LANE  
 SILVER LAKE, OR 97638

MAP TO ACCOMPANY  
 TRANSFER APPLICATION  
 CERTIFICATE 48606

DATE:	04/15/20
SCALE:	1"=1320'
DWG. BY:	R.C.
JOB:	2019-083
FILE:	2019-083
SHEET:	1 OF 1

CERTIFICATE 35750

SECTION 14, TOWNSHIP 27 SOUTH,  
RANGE 15 EAST, W.M.

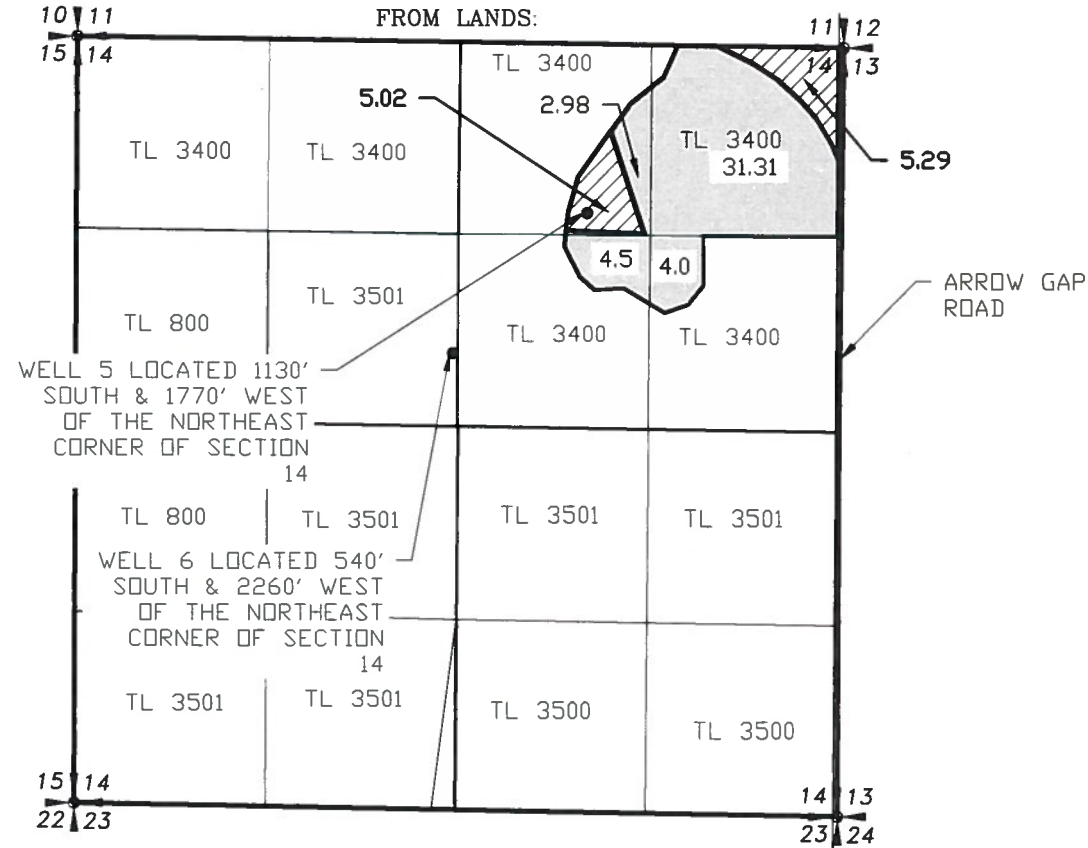

SECTION 18, TOWNSHIP 27 SOUTH,  
RANGE 16 EAST, W.M.

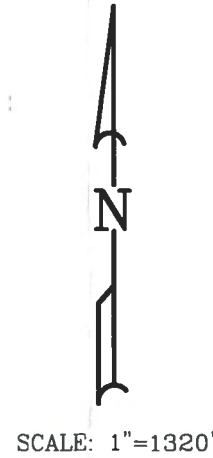
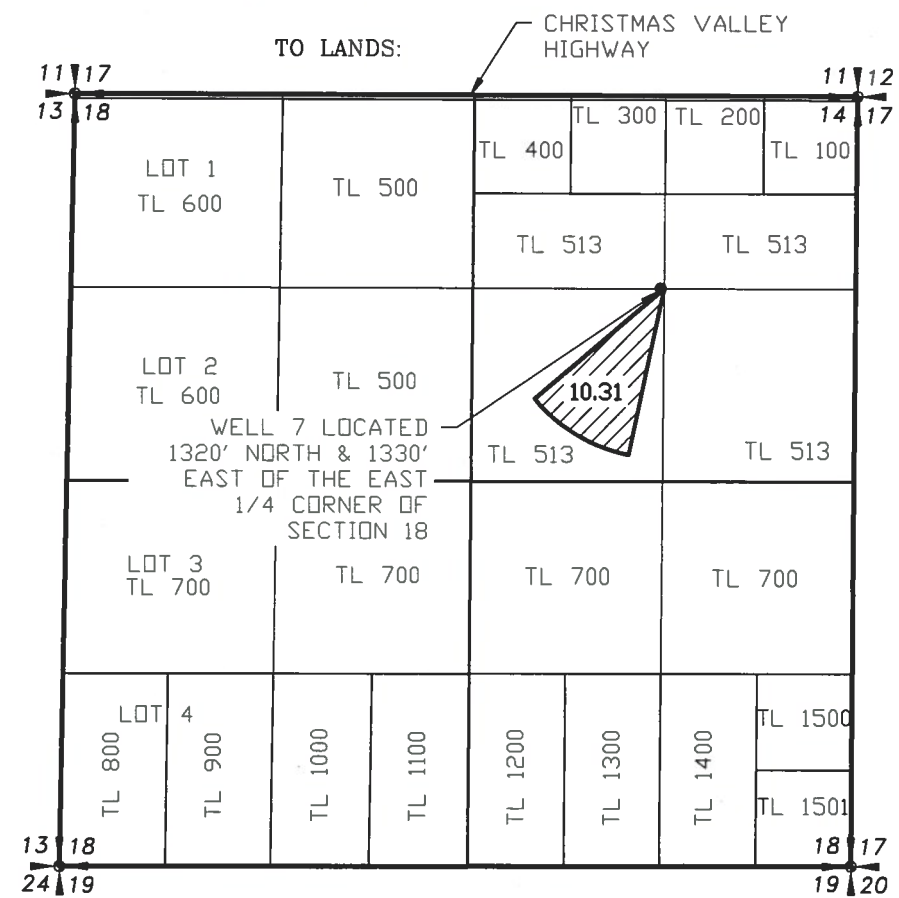

**LEGEND**

— SECTION LINE

— 1/4 SECTION LINE

- - - - 1/16 SECTION LINE

TO TRANSFER:

Certificate	35750	Priority	11/6/1958						
Township	Range	Mer	Sec	Q-Q	GLat	Well #	Acres	cf	
27 S	15 E	WM	14	NE NE		5	5.29	0.07	[Hatched Box]
27 S	15 E	WM	14	NW NE		5	5.02	0.06	
Total Acres this Certificate							10.31	0.13	

TO REMAIN:

Certificate	35750	Priority	11/6/1958						
Township	Range	Mer	Sec	Q-Q	GLat	Well #	Acres	cf	
27 S	15 E	WM	14	NE NE		5	31.31	0.39	[Solid Box]
27 S	15 E	WM	14	NW NE		5	2.98	0.04	
27 S	15 E	WM	14	SW NE		5	4.5	0.06	
27 S	15 E	WM	14	SE NE		5	4.0	0.03	
Total Acres this Certificate							42.79	0.53	

NEW LOCATION:

Certificate	35750	Priority	11/6/1958						
Township	Range	Mer	Sec	Q-Q	GLat	Well #	Acres	cf	
27 S	16 E	WM	18	SW NE		7	10.31	0.13	[Hatched Box]
Total Acres this Certificate							10.31	0.13	

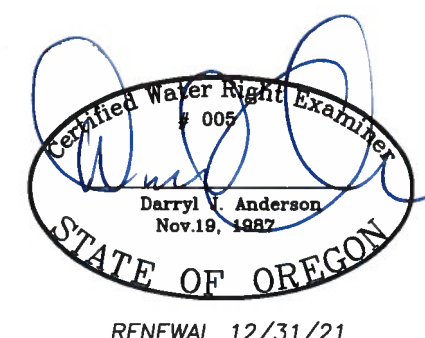

RECEIVED  
MAY 26 2020  
OWRD

NOTE:  
PREPARATION OF THIS MAP IS FOR IDENTIFYING WATER RIGHTS ONLY. IT HAS NO INTENT TO PROVIDE LOCATIONS OR DIMENSIONS OF PROPERTY BOUNDARIES.

REVISION	BY

**ANDERSON ENGINEERING AND SURVEYING, INC.**  
P.O. BOX 28  
LAKEVIEW, OREGON 97630  
(541) 947-4407  
FAX: 947-2321

FOR: DANIEL & LEANNE MILES  
81341 BUICK LANE  
SILVER LAKE, OR 97638

MAP TO ACCOMPANY  
TRANSFER APPLICATION  
CERTIFICATE 35750

DATE:	04/15/20
SCALE:	1"=1320'
DWG. BY:	R.C.
JOB:	2019-083
FILE:	2019-083
SHEET:	1 OF 1