

ROCK SOLID SAND & GRAVEL, LLC C/O WADE AYLETT
 TRANSFER APPLICATION MAP
 FOR A PORTION OF CERT 92150 AND A
 PORTION OF SUPPLEMENTAL CERT 89533
 SECTIONS 27 & 28
 T4N, R27E, WM UMATILLA AND MORROW COUNTIES

"FROM LAND"

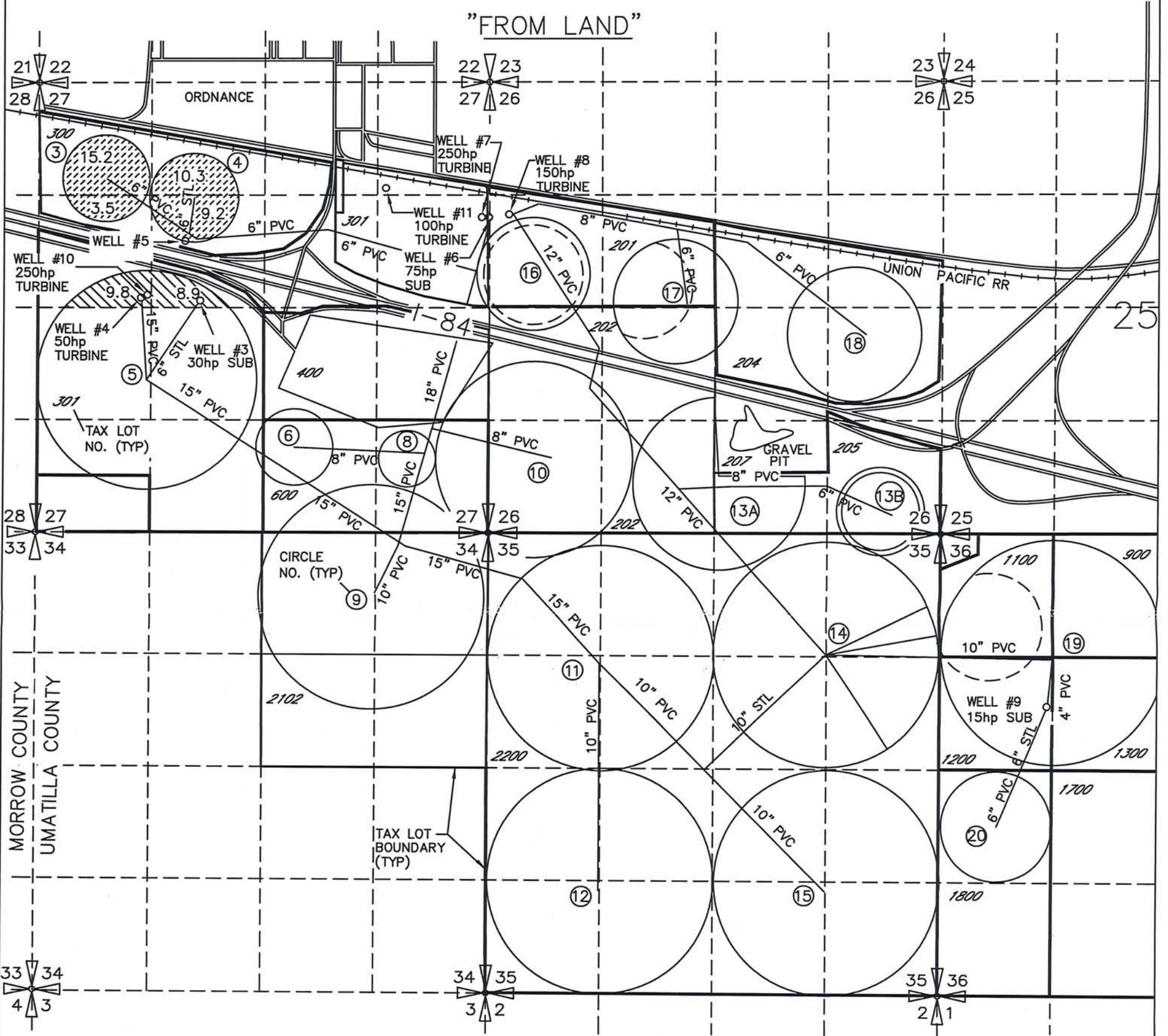

LEGEND AND LOCATION OF AUTHORIZED POAs

LOCATION OF AUTHORIZED POINTS OF APPROPRIATION AND FLOW METERS

- WELL 3 LOCATED 2740'N & 1890'E FROM SW COR SEC 27
- WELL 4 LOCATED 230'N & 1210'E FROM W1/4 COR SEC 27
- WELL 5 LOCATED 960'N & 1850'E FROM W1/4 COR SEC 27
- WELL 6,7 LOCATED 1130'N & 60'E FROM W1/4 COR SEC 26
- WELL 8 LOCATED 1160'N & 370'E FROM W1/4 COR SEC 26
- WELL 9 LOCATED 1884'S & 1315'E FROM NW COR SEC 36
- WELL 10 LOCATED 2880'N & 1310'E FROM SW COR SEC 27
- WELL 11 LOCATED 1300'S & 1215'W FROM NE COR SEC 27

- PORTION OF PRIMARY CERTIFICATE 92150 AND PORTION OF SUPPLEMENTAL CERTIFICATED 89533 BEING TRANSFERRED (38.2 AC)
- ACRES OF SUPPLEMENTAL CERTIFICATE 89533 IN SAME QUARTER QUARTER NOT INVOLVED IN THIS TRANSFER

NOTE: THE PURPOSE OF THIS MAP IS TO IDENTIFY THE APPROXIMATE LOCATION OF THE WATER RIGHT. IT IS NOT INTENDED TO PROVIDE INFORMATION RELATIVE TO THE LOCATION OF PROPERTY OWNERSHIP BOUNDARY LINES. PIPELINE LOCATIONS AND SIZES WERE PROVIDED BY THE WATER USER AND HAVE NOT BEEN VERIFIED.

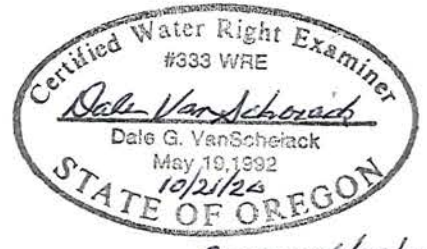
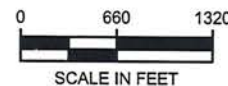

Ratified 6/30/22

DGV Consulting, PLLC
 PHONE (509) 627-8717
 dalevconsulting@gmail.com
 Date: Oct 11, 2020

RECEIVED

OCT 27 2020

OWRD

T4N R27E W.M.

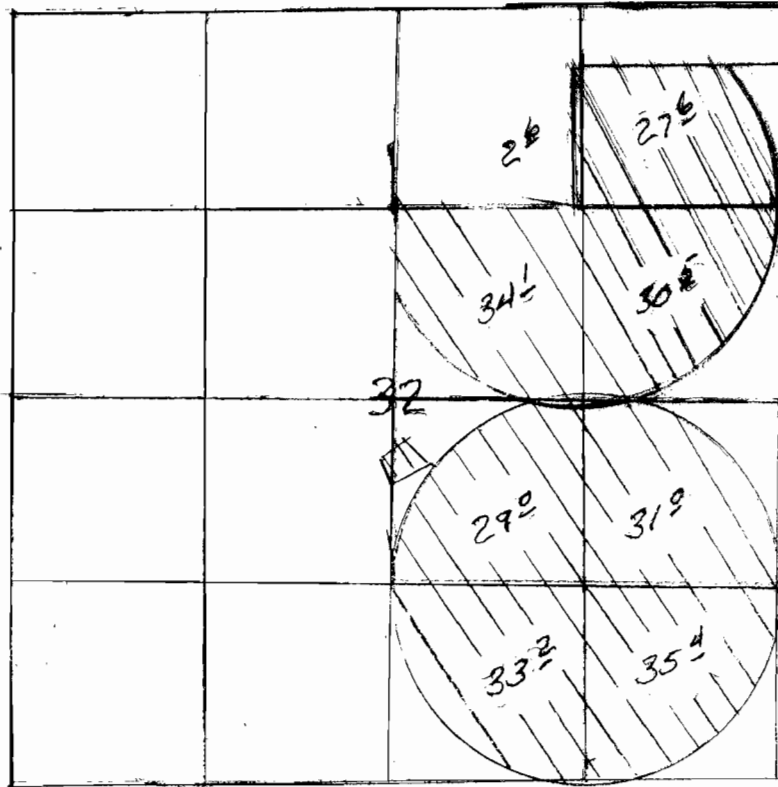

1" = 1320'

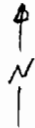

PARTIAL
FINAL PROOF SURVEY
UNDER

Application No. G-8649 Permit No. G-10836
IN NAME OF

CLWID

Surveyed APR 15-18 1995, by J. Miller

AMENDED 8/28/06 LHN
NAPP 1208-149R LHN

T4N R27E W.M.

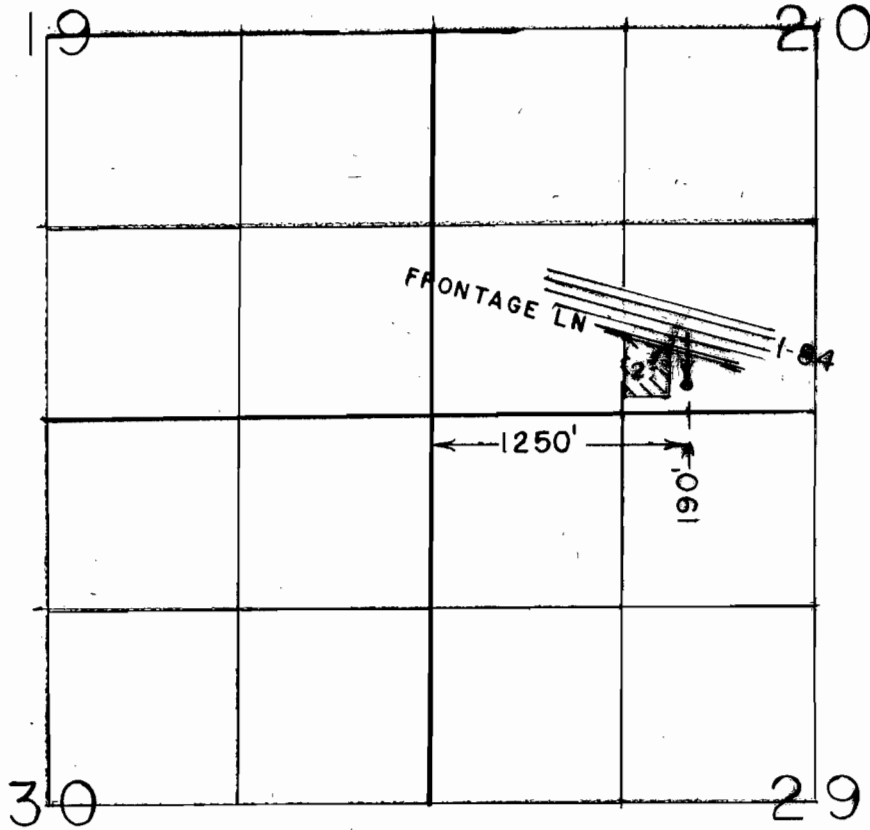

FINAL PROOF SURVEY
UNDER

TRANSFER 5737

Application No. Permit No.

IN NAME OF

..... THOMAS & PAMELA MANN

Surveyed AUG.... 1995., by J. MILLER.....

T. 4N., R. 27E. W. M.

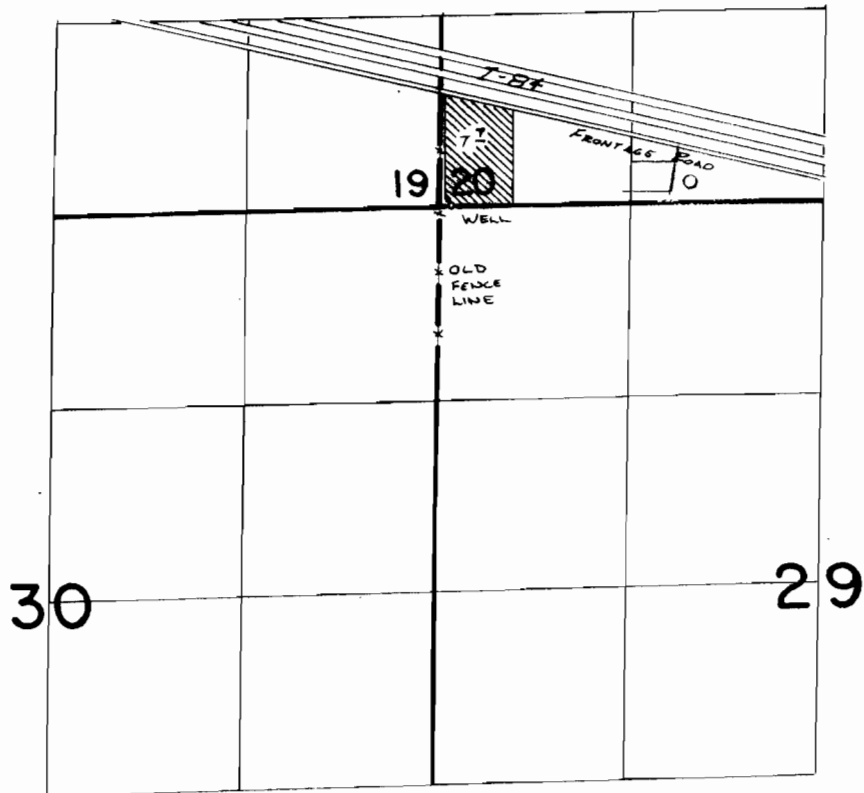

WELL LOC: 10' N. & 90° E. FROM SW COR. SEC 20

FINAL PROOF SURVEY
UNDER

Application No. **G:5590** Permit No. **G:4932**
IN NAME OF





.....**JOSE SOLANO**.....

Surveyed Feb. 14 1983, by V.L. Church

T4N, R27E, W.M.
MORROW COUNTY, OREGON
FINAL PROOF SURVEY

T-6097, T-6098, T-6099, T-6100, T-6101 and T-6102

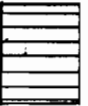
IN THE NAME OF
JEDEDIAH AYLETT
 Rt. 1, Box 1818
 Hermiston, Ore. 97838
 567-5938

-  T-6097
-  T-6098
-  T-6099
-  T-6100
-  T-6101
-  T-6102

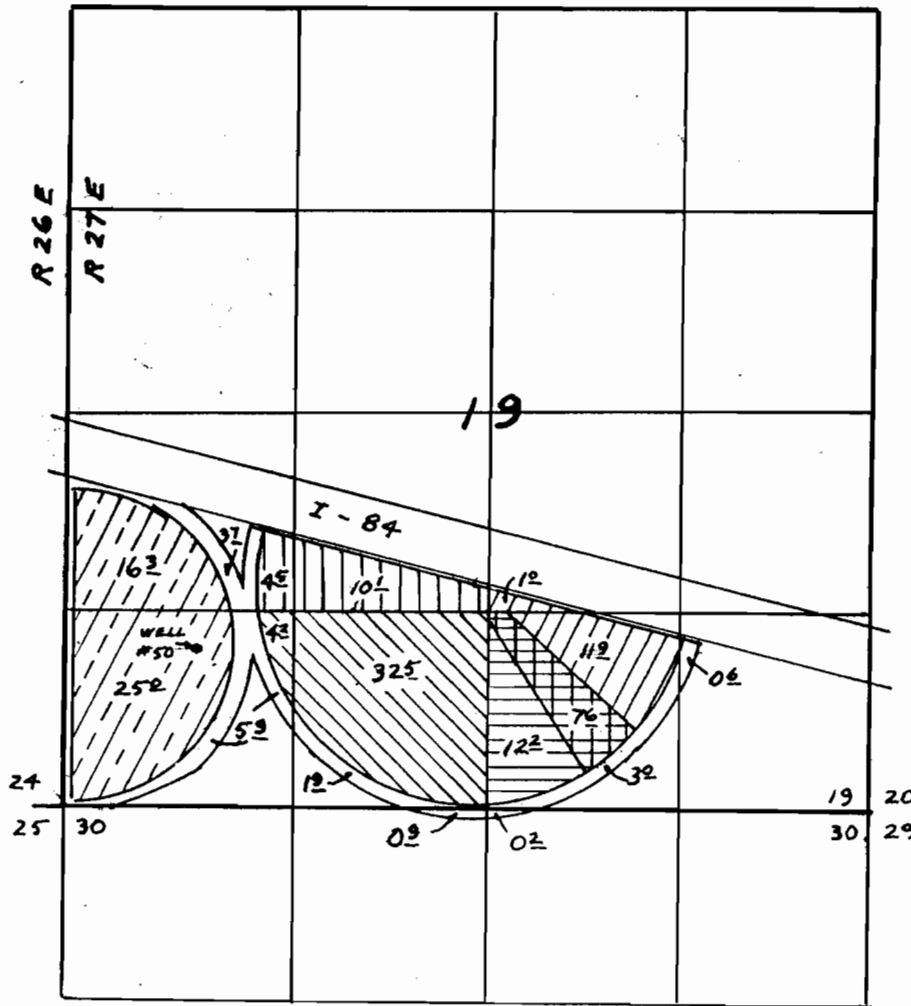

Scale: 1" = 1320'

Well # 50 lies 1077 feet N. and 910 feet E.
 of SW corner of Section 19.

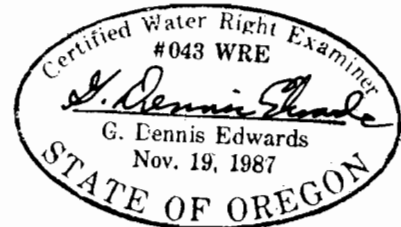

Edwards Surveying P.O. Box 763
 567-3336 Hermiston, OR. 97838
 10/1/91 Job # W8803009-A

This map is for identifying the location
 of water rights only and is not intended
 to show property lines or dimensions.

T7105



RECEIVED

MAR 04 1994

WATER RESOURCES DEPT.
SALEM, OREGON

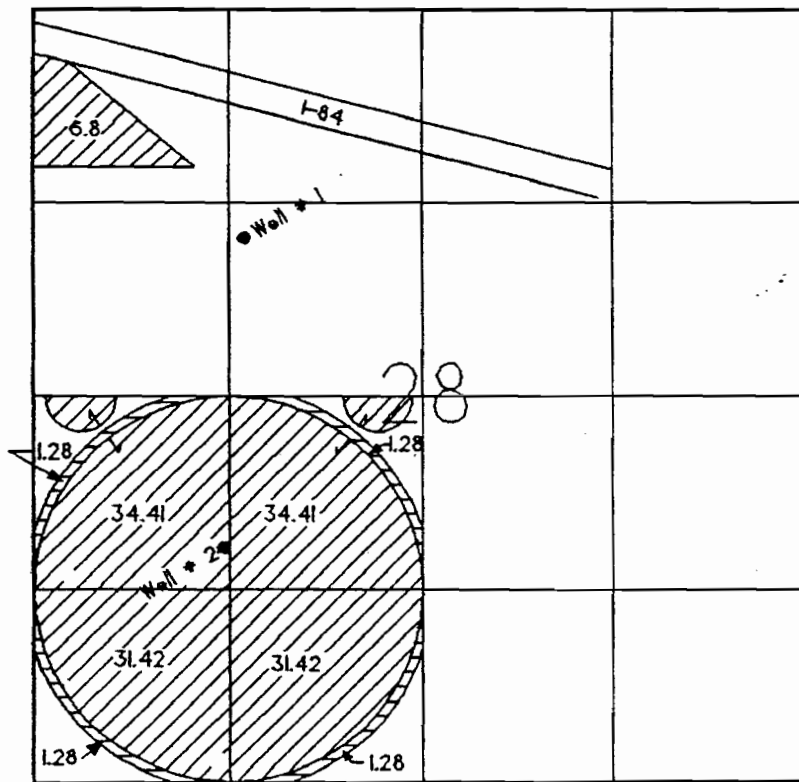
T 4 N. R 27 E. W. M.
MORROW COUNTY, OR
SCALE: 1" = 1320'



-  CERT. NO. 30019 TO STAY
-  CERT. NO 30019

This map is for identifying the location of water rights only and is not intended to show property lines or dimensions.

RECEIVED

APR 22 1988

T4N, R27E, W.M., MORROW COUNTY, OREGON WATER RESOURCES DEPT. SALEM, OREGON

T-6099

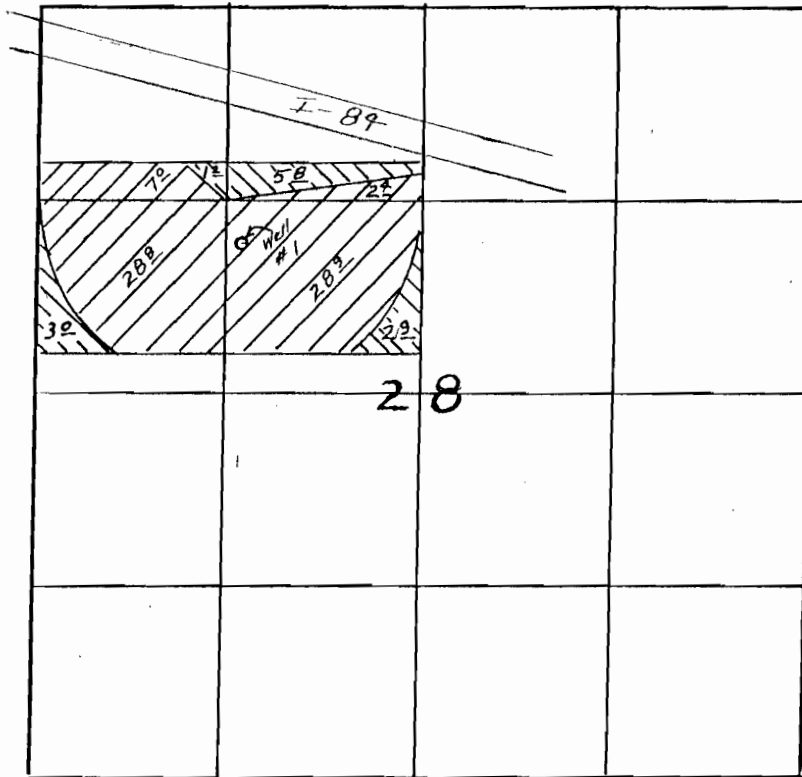

SCALE : 1" = 1320'



U 497 #26073 To Stay



U 497 #26073 To Transfer

source is Well #1 which lies 3700' N & 1420' E of SW Cor Sec 28

This map is for identifying the location of water rights only and is not intended to show property lines or dimensions

Application Map for Jedediah Aylett

4/15/88

Job # 8803009-B

Edwards Surveying P.O. Box 763

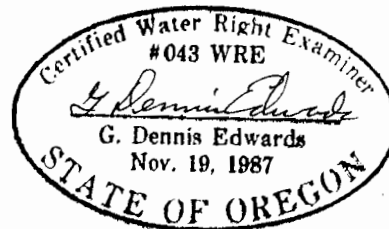

T-6102

T4N., R 27E, W.M., MORROW COUNTY, OR

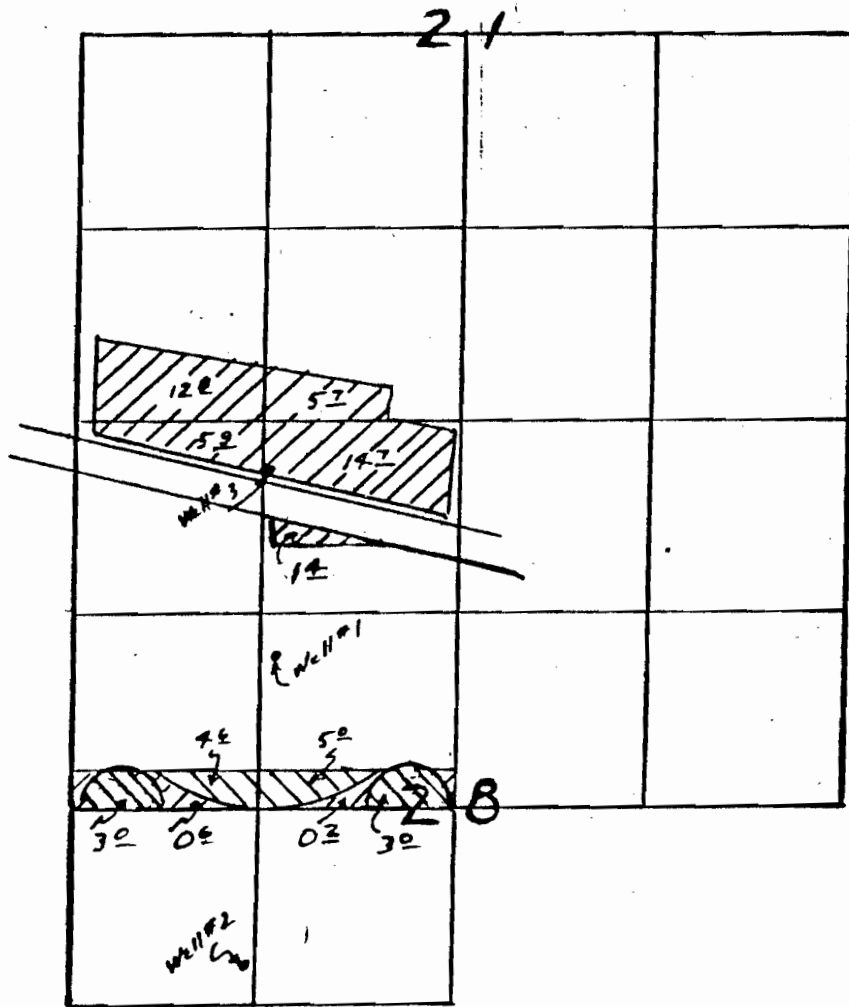

SCALE: 1" = 1320'



G 4929 To stay



G 4929 To Transfer

Points of Diversion are

Well #1 56 Chains N & 21.5 Chains E of SW Cor. Sec. 28

Well #2 24.5 Chains N & 19.5 Chains E of SW Cor. Sec. 28

Well #3 IN NE 1/4 NW 1/4 Sec. 28

This map is for identifying the location of water rights only and is not intended to show property lines or dimensions

Application Map for Jedediah Aylett

4/15/89

Job # BB03009-E

Rev. 7/9/88

Rev. 8/23/88

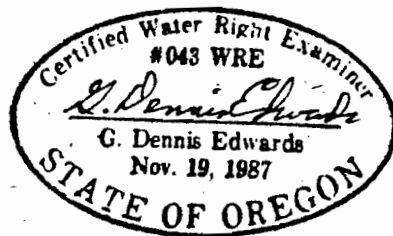

T.4N., R.27E., W.M.

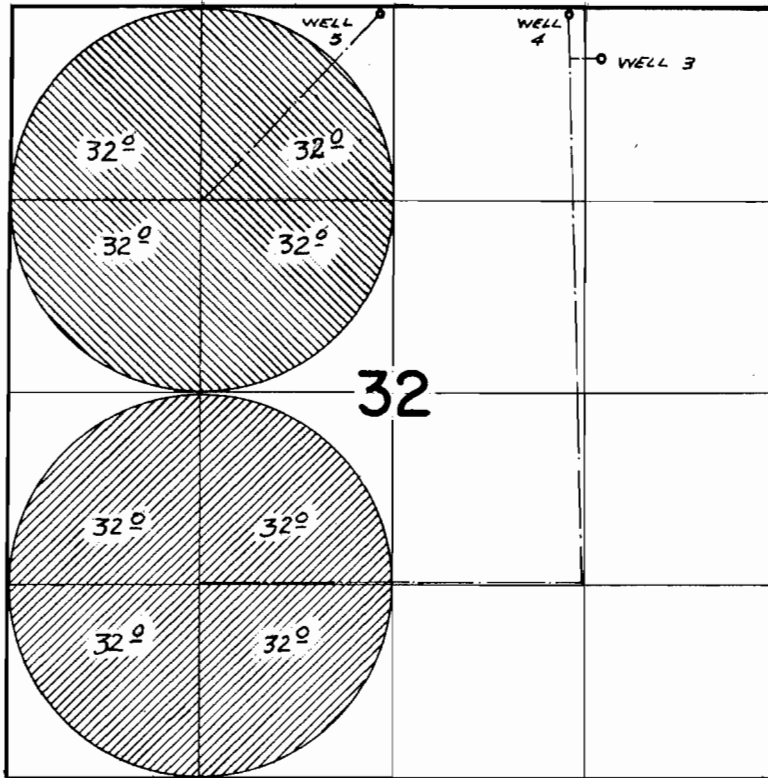

WELLS LOCATED: #3- 340'S & 1190' W; #4- 50'S & 1410' W; #5- 50'S & 2710' W
ALL FROM NE COR 32.

FINAL PROOF SURVEY
UNDER

Application No. **G-3853** Permit No. **G-3629**
G-4140 **G-3889**
IN NAME OF



ESTATE OF ROY GAIL HOLZAPFEL

Surveyed April 10 1974, by David Forby

T.4N., R.27E., W.M.

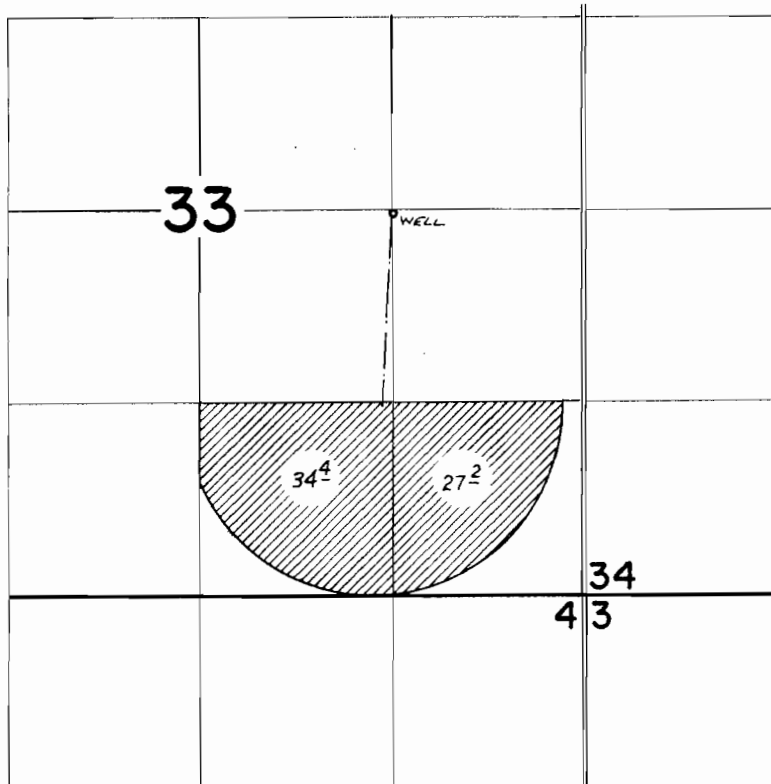

WELL LOC: 16'S & 1310' W FROM E $\frac{1}{4}$ COR. SEC 33.

FINAL PROOF SURVEY
UNDER

Application No. G-5112 Permit No. G-4821
IN NAME OF

JEDEDIAH WM. AND JUANITA AYLETT

Surveyed APR 11 1974, by *R. Norby*

T.3N.,R.27E.,W.M.

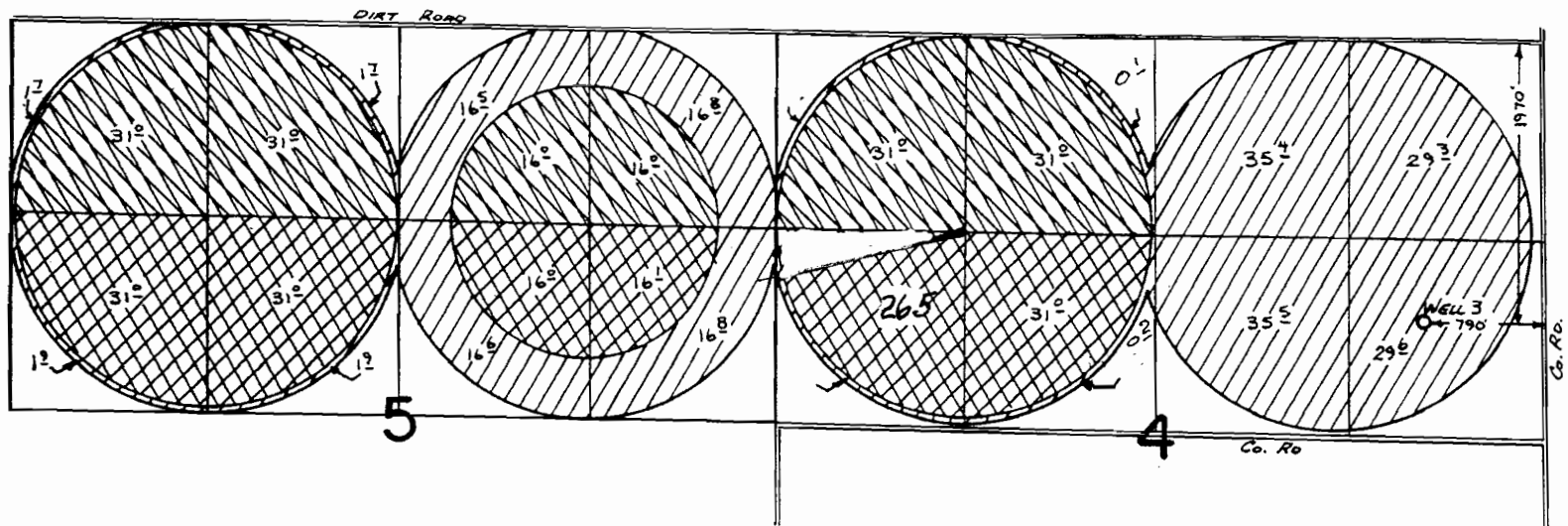

T.4N.,R.27E.,W.M.

30

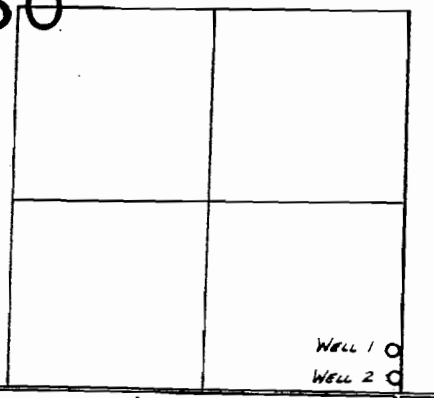

WELL 1 - 290' N and 50' W
 WELL 2 - 100' N and 40' W
 BOTH FROM SE COR. SEC. 30

SUPERSEDING
FINAL PROOF SURVEY
 UNDER

Transfer No. 3393

Application No. G-3092 Permit No. G-2823

G-5145 G-4878

IN NAME OF

JIM & DON KEY

Surveyed August 4, 1978 by R. BARWIN

April 11, 1975 by R. G. MUCKEN

MODIFIED FOR
 PERMIT G-10836
 4/5/06 LHM

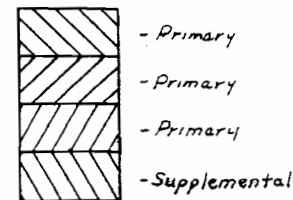

T 7105

RECEIVED

MAR 04 1994

WATER RESOURCES DEPT.
SALEM, OREGON

T 4 N. R 27 E. W. M.
MORROW COUNTY, OR
SCALE: 1" = 1320'

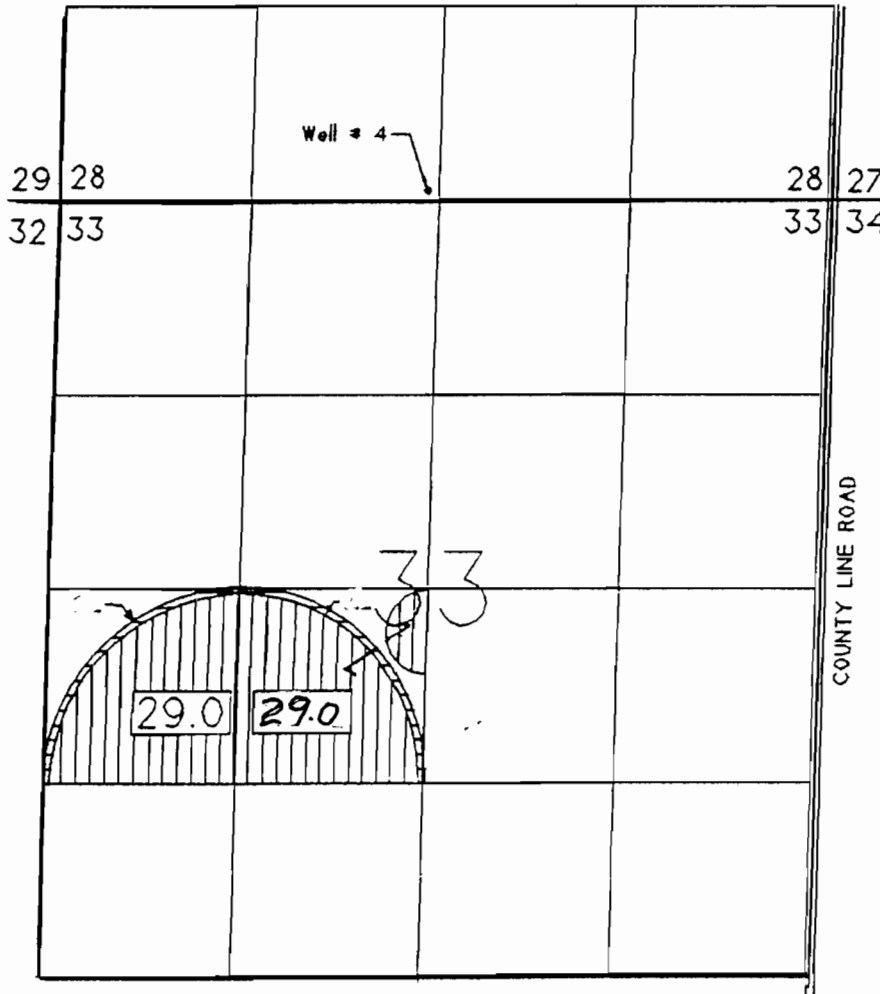

 CERT. NO. 49077
TO STAY

 CERT. NO 49077
TO TRANSFER

Well No. 4 lies 90' N. and
40' W. of the S 1/4 Cor.
of Section 28.

APPLICATION MAP FOR
JEDEDIAH AYLETT
RT. 1, BOX 1818 HERMISTON, OR
503 567 5938 97838

EDWARDS SURVEYING P. O. BOX 763
HERMISTON, OR. 97838 503 567 3336
2/1/94 JOB NO. W9402014

This map is for identifying the location of
water rights only and is not intended to
show property lines or dimensions.

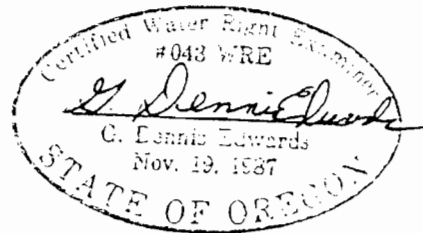

MODIFIED FOR
PERMIT 6-10836
4/5/06 LHN.

T 7105
RECEIVED

MAR 04 1994

WATER RESOURCES DEP.
SALEM, OREGON

T 4 N. R 27 E. W. M.
MORROW COUNTY, OR
SCALE: 1" = 1320'

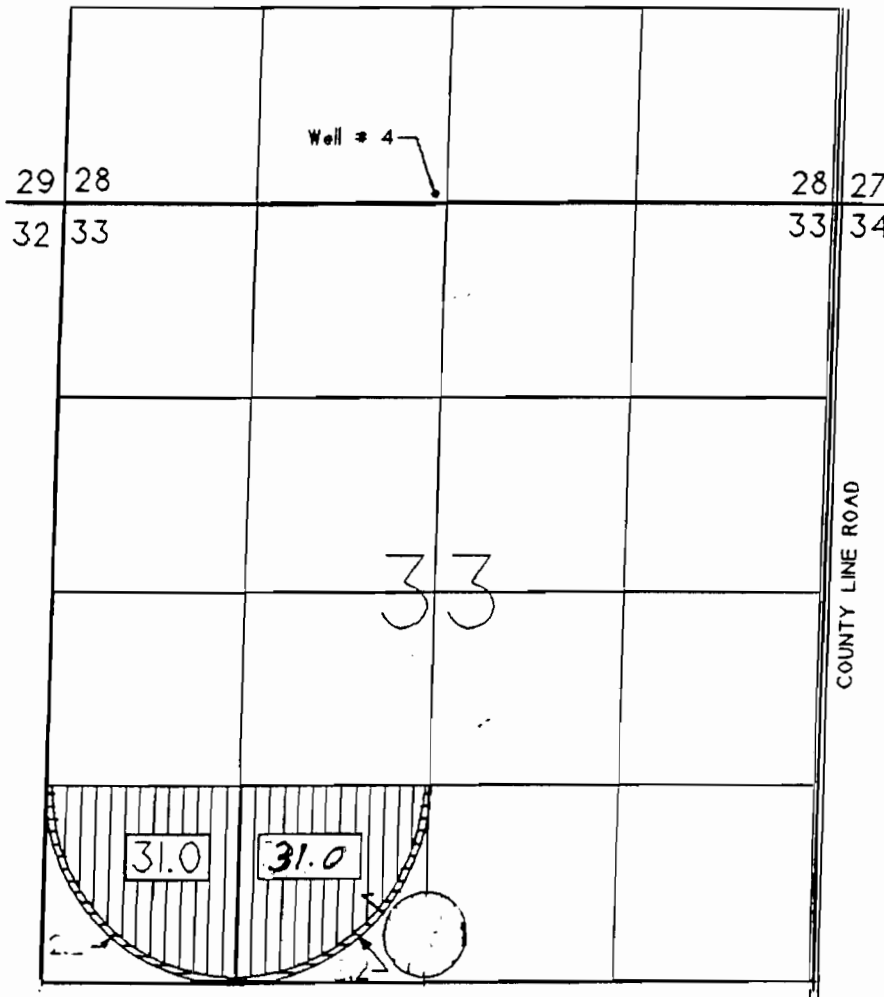

 CERT. NO. 49076
TO STAY

 CERT. NO. 49076
TO TRANSFER

Well No. 4 lies 90' N. and
40' W. of the S 1/4 Cor.
of Section 28.

APPLICATION MAP FOR
JEDEDIAH AYLETT
RT. 1, BOX 1818 HERMISTON, OR
503 567 5938 97838

EDWARDS SURVEYING P. O. BOX 763
HERMISTON, OR. 97838 503 567 3336
2/1/94 JOB NO. W9402014

This map is for identifying the location of
water rights only and is not intended to
show property lines or dimensions.

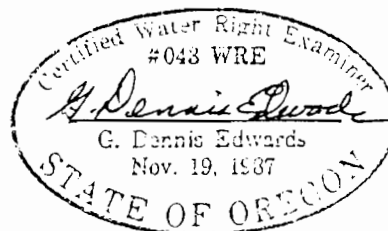

MODIFIED FOR
PERMIT G-10836
4/5/06 LAN

T-6100
RECEIVED

JUL 15 1988

WATER RESOURCES DEPT
SALEM, OREGON

T4N, R 27E, W.M., MORROW COUNTY, OR

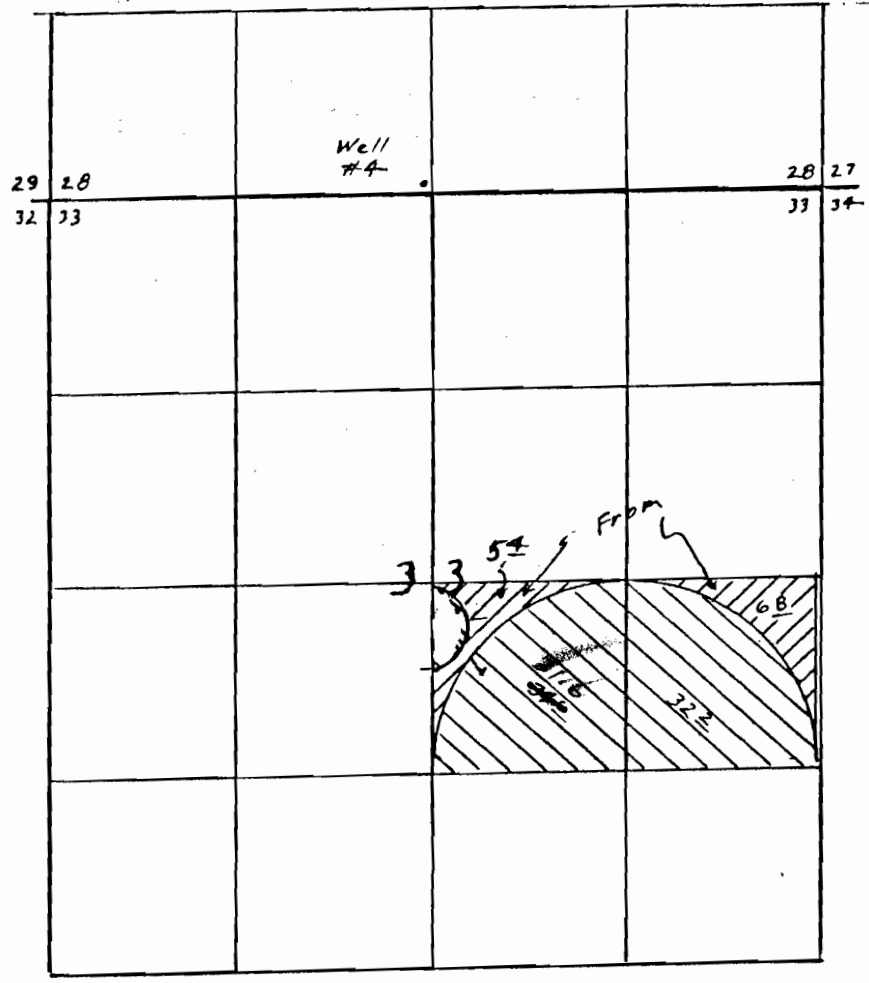

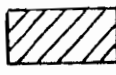
-  U-363 To Stay #48549
-  U-363 To Transfer #48549

Source is well #4
90' N & 40' W 1/4 cor. Sec 28

This map is for identifying the location of water rights only and is not intended to show property lines or dimensions

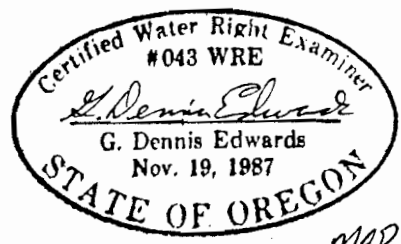

Application Map for Jedediah Aylett

7/15/88
7/9/88

Job # BB03009-C

MODIFIED FOR
PERMIT G-10836
4/5/06 LHN

T. 4 N., R. 27 E., W. M.

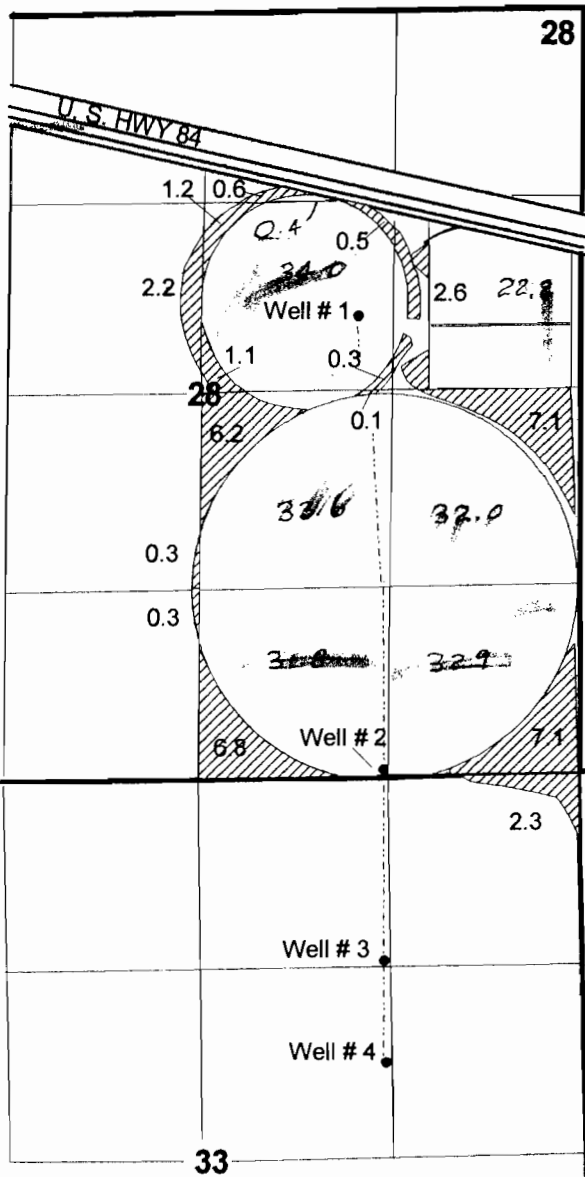

RECEIVED

DEC 02 2004

WATER RESOURCES DEPT
SALEM, OREGON



1" = 1320'

- WELL # 1 - 3180' N. & 1470' W. FROM SE COR. SECTION 28.
- WELL # 2 - 20' N. & 1350' W. FROM SE COR. SECTION 28.
- WELL # 3 - 1270' S. & 1350' W. FROM NE COR. SECTION 33.
- WELL # 4 - 1940' S. & 1350' W. FROM NE COR. SECTION 33.

FINAL PROOF SURVEY

UNDER

Application G-5026 Permit G-10504

IN THE NAME OF
12-H, INC.

Surveyed Aug. 15, 2003, By J. Miller

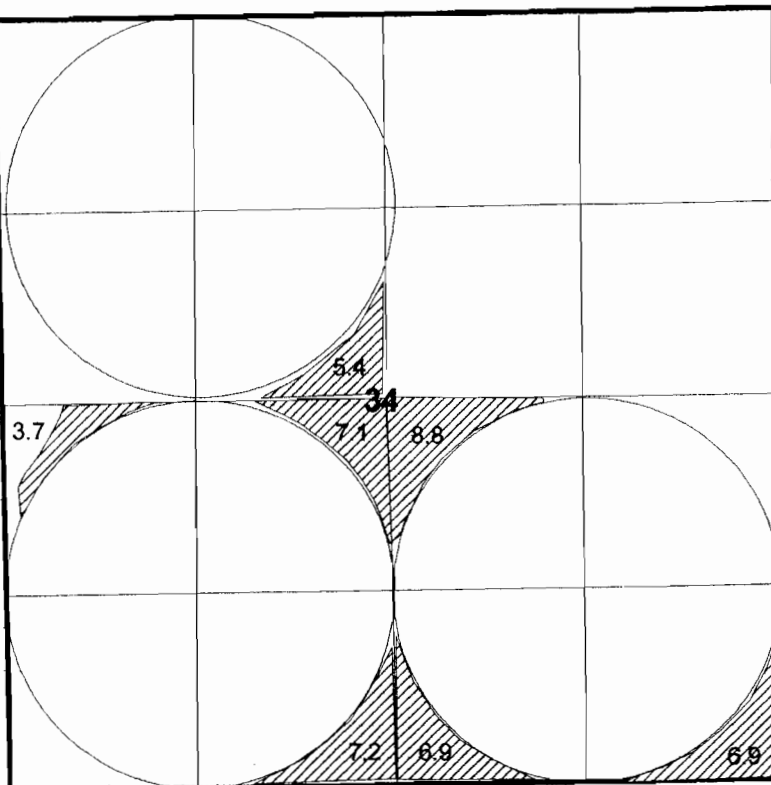

MODIFIED FOR
PERMIT G-10836
4/5/06 LHN

11/16/2004 JM

HANSELL BROTHERS INC.
ADDITIONAL POINT OF APPROPRIATION AMENDED
TRANSFER T-9275 APPLICATION MAP 2 of 4
WATER RIGHTS
 T. 4N., R.27E., W.M. UMATILLA COUNTY, OREGON

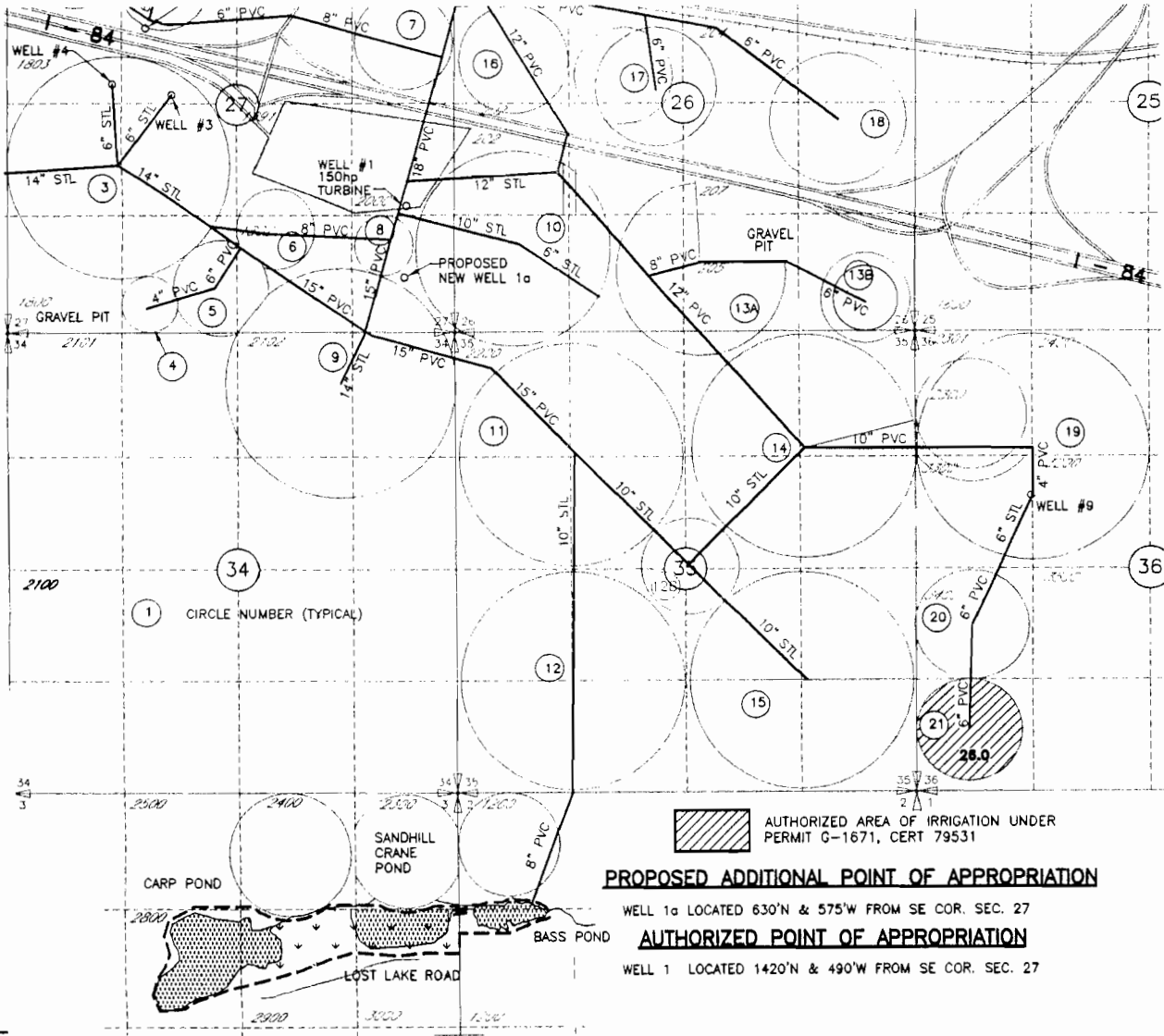

0 2640
 1 FEET

 AUTHORIZED AREA OF IRRIGATION UNDER PERMIT G-1671, CERT 79531
PROPOSED ADDITIONAL POINT OF APPROPRIATION
 WELL 1a LOCATED 630'N & 575'W FROM SE COR. SEC. 27
AUTHORIZED POINT OF APPROPRIATION
 WELL 1 LOCATED 1420'N & 490'W FROM SE COR. SEC. 27





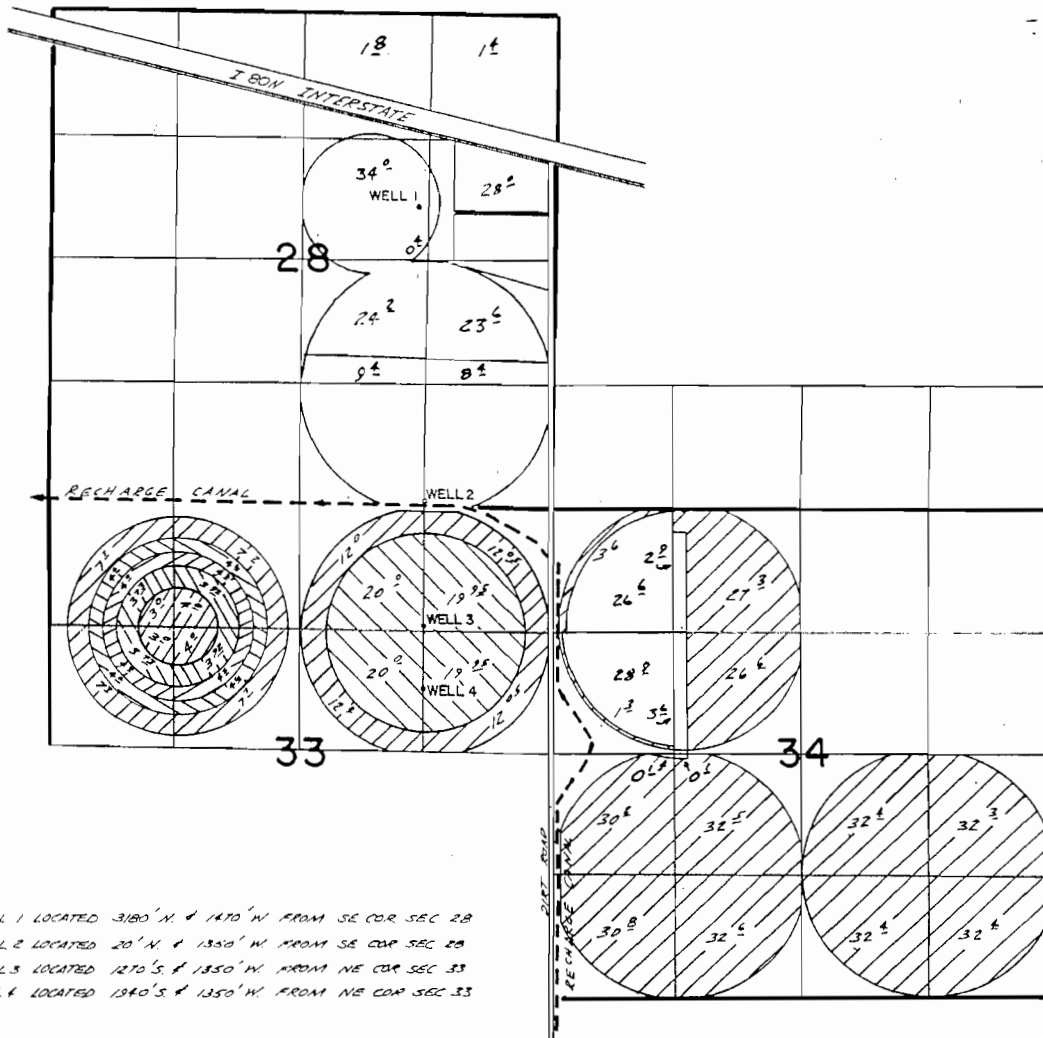

Certified Water Right Examiner
 #333 WRE
Dale G. VanSchoyck
 Dale G. VanSchoyck
 May 19, 1982
 State of Oregon

 **SCM** Consult
 A Tetra Tech
 DRAWING: H:\020\00351
 PRINTED BY: roggers on 1

P IS TO IDENTIFY THE APPROXIMATE LOCATION IS NOT INTENDED TO PROVIDE INFORMATION I OF PROPERTY OWNERSHIP BOUNDARY LINES.



WELL 1 LOCATED 3180' N. & 1470' W. FROM SE COR. SEC. 28
 WELL 2 LOCATED 20' N. & 1350' W. FROM SE COR. SEC. 28
 WELL 3 LOCATED 1270' S. & 1350' W. FROM NE COR. SEC. 33
 WELL 4 LOCATED 1340' S. & 1350' W. FROM NE COR. SEC. 33

- | | | | |
|---|------------|---|--------|
|  | PER G-2822 |  | T-3902 |
|  | T-3903 |  | T-3904 |
|  | T-3905 |  | T-4089 |

FINAL PROOF SURVEY
 UNDER

APPL. G-2831 PER. G-2822
 TRANSFERS

3902 3903 3904
 3905 4089

IN NAME OF
I2H, INC.

SURVEYED 8-2 1978, BY R. BARWIN

V.L.C.

HANSELL BROTHERS INC. FINAL PROOF
 AMENDED DECEMBER 11, 1996 and 2-4-97

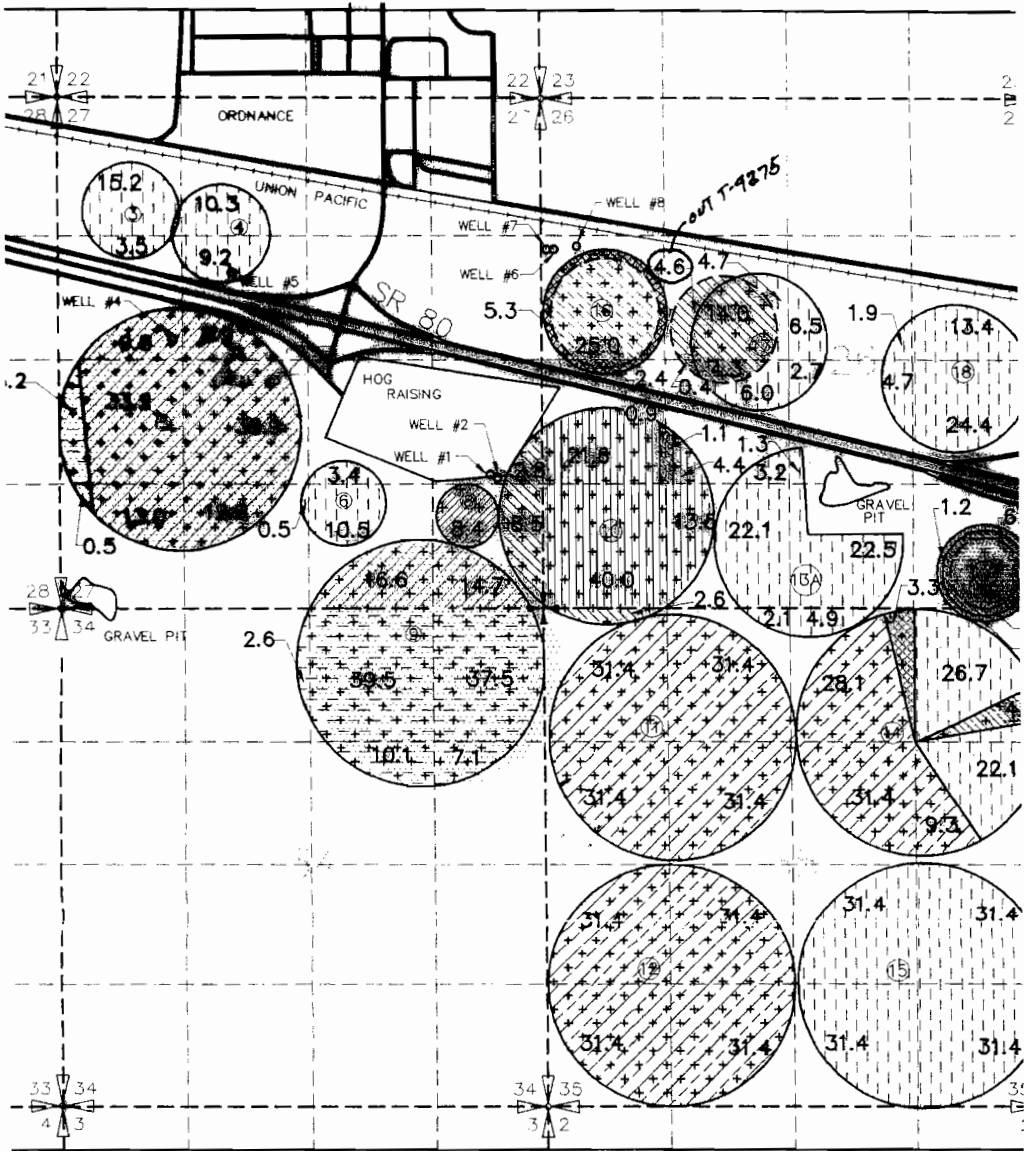

- LL 1 LOCATED 1420'N & 490'W FROM SE COR. SEC.27 BEING WITHIN NE 1/4 SE 1/4
- LL 2 LOCATED 1390'N & 430'W FROM SE COR. SEC.27 BEING WITHIN NE 1/4 SE 1/4
- LL 3 LOCATED 2740'N & 1890'E FROM SW COR. SEC.27 BEING WITHIN SE 1/4 NW 1/4
- LL 4 LOCATED 230'N & 1210'E FROM W 1/4 COR. SEC.27 BEING WITHIN SW 1/4 NW 1/4
- WELL 5 LOCATED 960'N & 1850'E FROM W 1/4
- WELL 6,7 LOCATED 1130'N & 60'E FROM W 1/4 Ct
- WELL 8 LOCATED 1160'N & 370'E FROM W 1/4 C
- WELL 9 LOCATED 1884'S & 1315'E FROM NW Ct

	T-4152		PERMIT NO. G-2694		CIRCLE NUMBER
	PERMIT NO. U-649		T-4928	31.4	IRRIGATED ACREAGE
	PERMIT NO. G-3822 SUPPLEMENTAL & T-4929		PERMIT NO. G-2335		
	G-3822 PRIMARY		T-4926		

**JEDEDIAH W. AYLETT
TRANSFER APPLICATION MAP
FOR CERTIFICATE 87298
T4N, R27E, W.M., MORROW COUNTY
MAP 1 OF 7**

FROM

TO

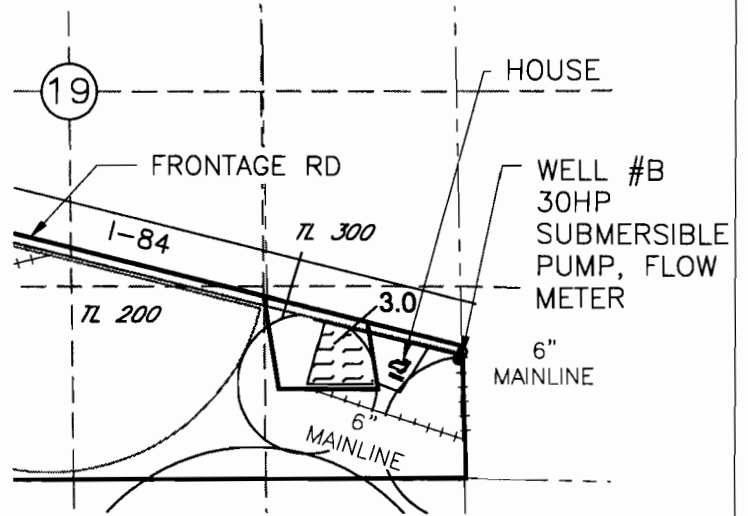
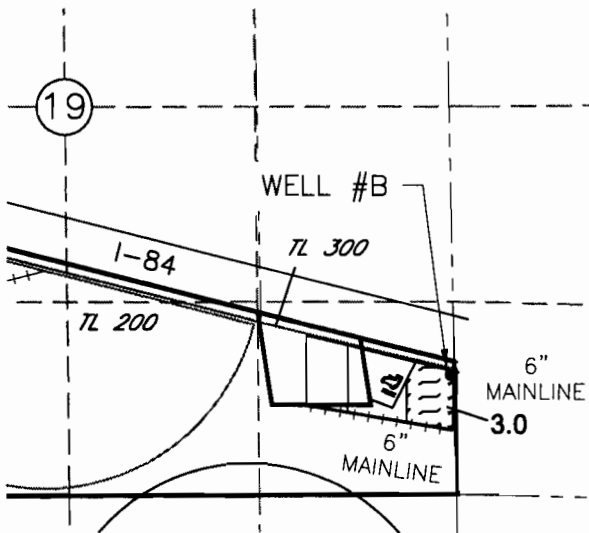

WELL #B LOCATED 790' N AND 55' W FROM THE SE COR SEC 19

LEGEND



AC OF CERT 87298 TO BE TRANSFERRED

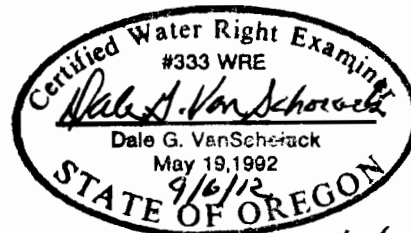

Renewal 6/30/14

RECEIVED BY OWRD

DEC 28 2012

SALEM, OR

NOTE:
THE PURPOSE OF THIS MAP IS TO IDENTIFY THE APPROXIMATE LOCATION OF THE WATER RIGHT. IT IS NOT INTENDED TO PROVIDE INFORMATION RELATIVE TO THE LOCATION OF PROPERTY OWNERSHIP BOUNDARY LINES.

THE PIPE DISTRIBUTION SYSTEM IS BURIED PIPE. LOCATIONS AND SIZES ARE APPROXIMATE. THEY ARE BASED ON FARM MAPS, FIELD OBSERVATIONS AND DESCRIPTIONS PROVIDED BY OPERATIONS PERSONNEL.

**JEDEDIAH W. AYLETT
TRANSFER APPLICATION MAP
FOR CERTIFICATE 87299
T4N, R27E, W.M., MORROW COUNTY
MAP 2 OF 7**

FROM

TO

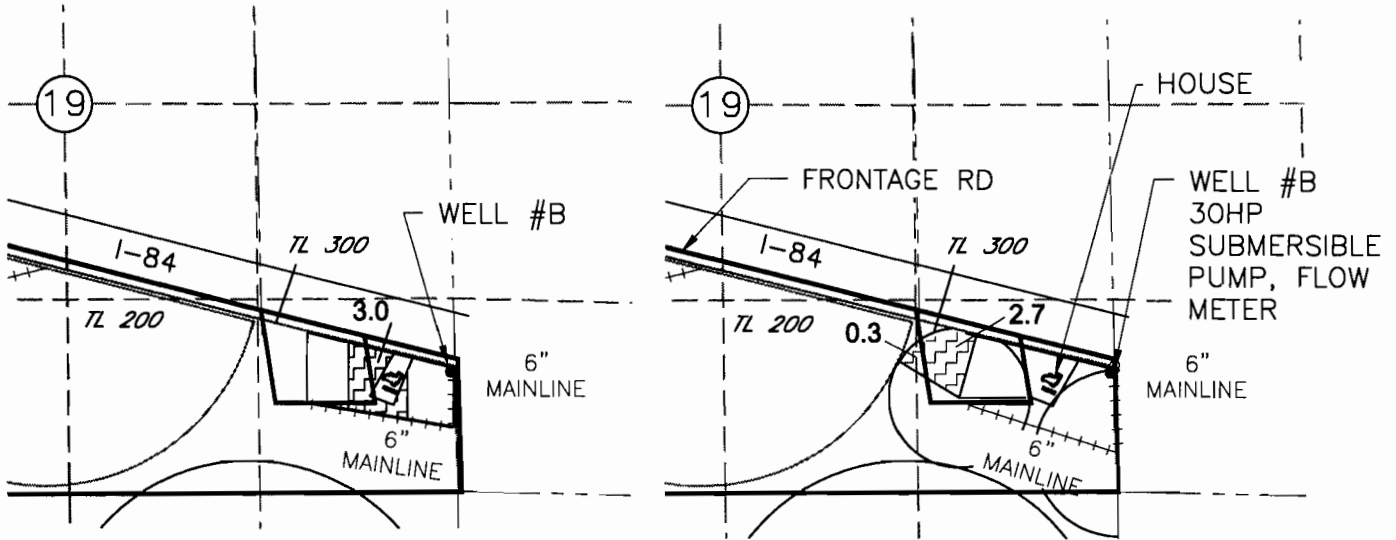

WELL #B LOCATED 790' N AND 55' W FROM THE SE COR SEC 19

LEGEND



AC OF CERT 87299 TO BE TRANSFERRED

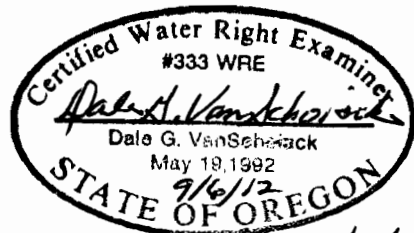

RECEIVED BY OWRD

DEC 28 2012

SALEM, OR

NOTE:
THE PURPOSE OF THIS MAP IS TO IDENTIFY THE APPROXIMATE LOCATION OF THE WATER RIGHT. IT IS NOT INTENDED TO PROVIDE INFORMATION RELATIVE TO THE LOCATION OF PROPERTY OWNERSHIP BOUNDARY LINES.

THE PIPE DISTRIBUTION SYSTEM IS BURIED PIPE. LOCATIONS AND SIZES ARE APPROXIMATE. THEY ARE BASED ON FARM MAPS, FIELD OBSERVATIONS AND DESCRIPTIONS PROVIDED BY OPERATIONS PERSONNEL.

**JEDEDIAH W. AYLETT
TRANSFER APPLICATION MAP
FOR CERTIFICATE 87300
T4N, R27E, W.M., MORROW COUNTY
MAP 3 OF 7**

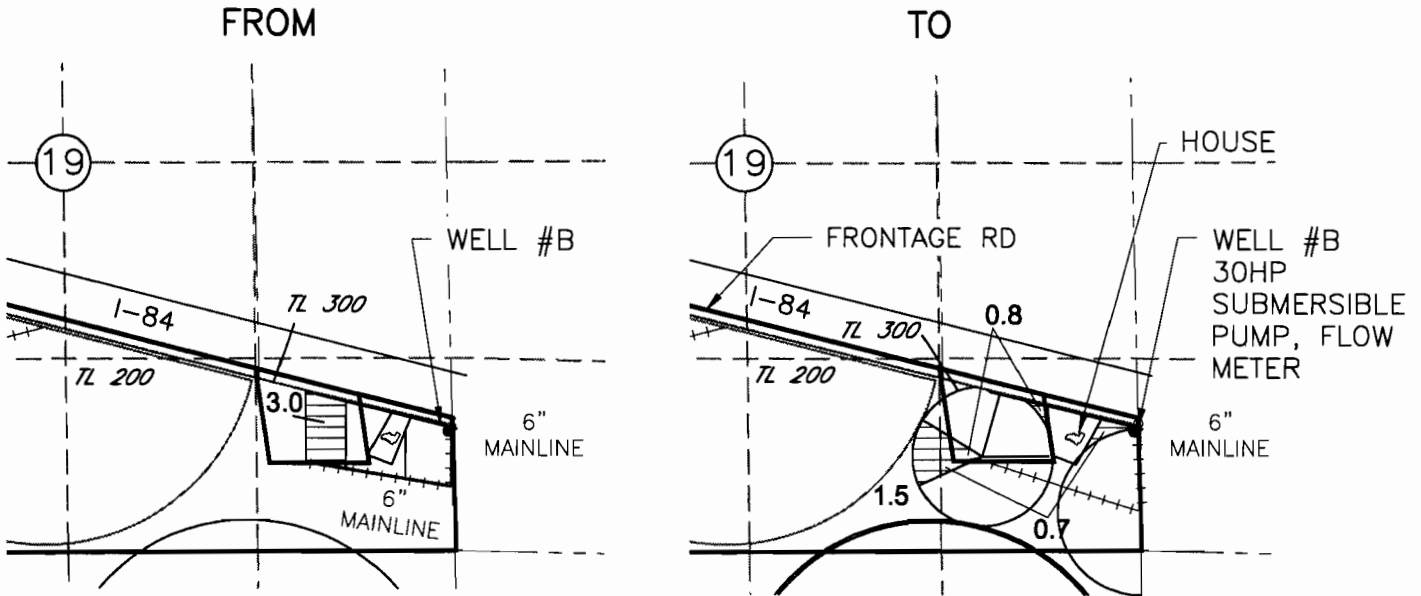

WELL #B LOCATED 790' N AND 55' W FROM THE SE COR SEC 19

LEGEND



AC OF CERT 87300 TO BE TRANSFERRED

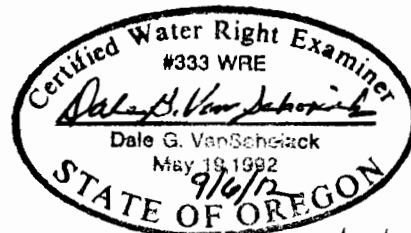
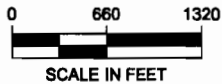

Renews 6/30/14
RECEIVED BY OWRD

DEC 28 2012

SALEM, OR

NOTE:
THE PURPOSE OF THIS MAP IS TO IDENTIFY THE APPROXIMATE LOCATION OF THE WATER RIGHT. IT IS NOT INTENDED TO PROVIDE INFORMATION RELATIVE TO THE LOCATION OF PROPERTY OWNERSHIP BOUNDARY LINES.

THE PIPE DISTRIBUTION SYSTEM IS BURIED PIPE. LOCATIONS AND SIZES ARE APPROXIMATE. THEY ARE BASED ON FARM MAPS, FIELD OBSERVATIONS AND DESCRIPTIONS PROVIDED BY OPERATIONS PERSONNEL.

JEDEDIAH W. AYLETT
TRANSFER APPLICATION MAP FOR A PORTION OF RECEIVED BY OWRD
CERTIFICATE 60552 AND CERTIFICATE 84119
T4N, R27E, W.M., MORROW COUNTY
MAP 4 OF 7

DEC 28 2012

SALEM, OR

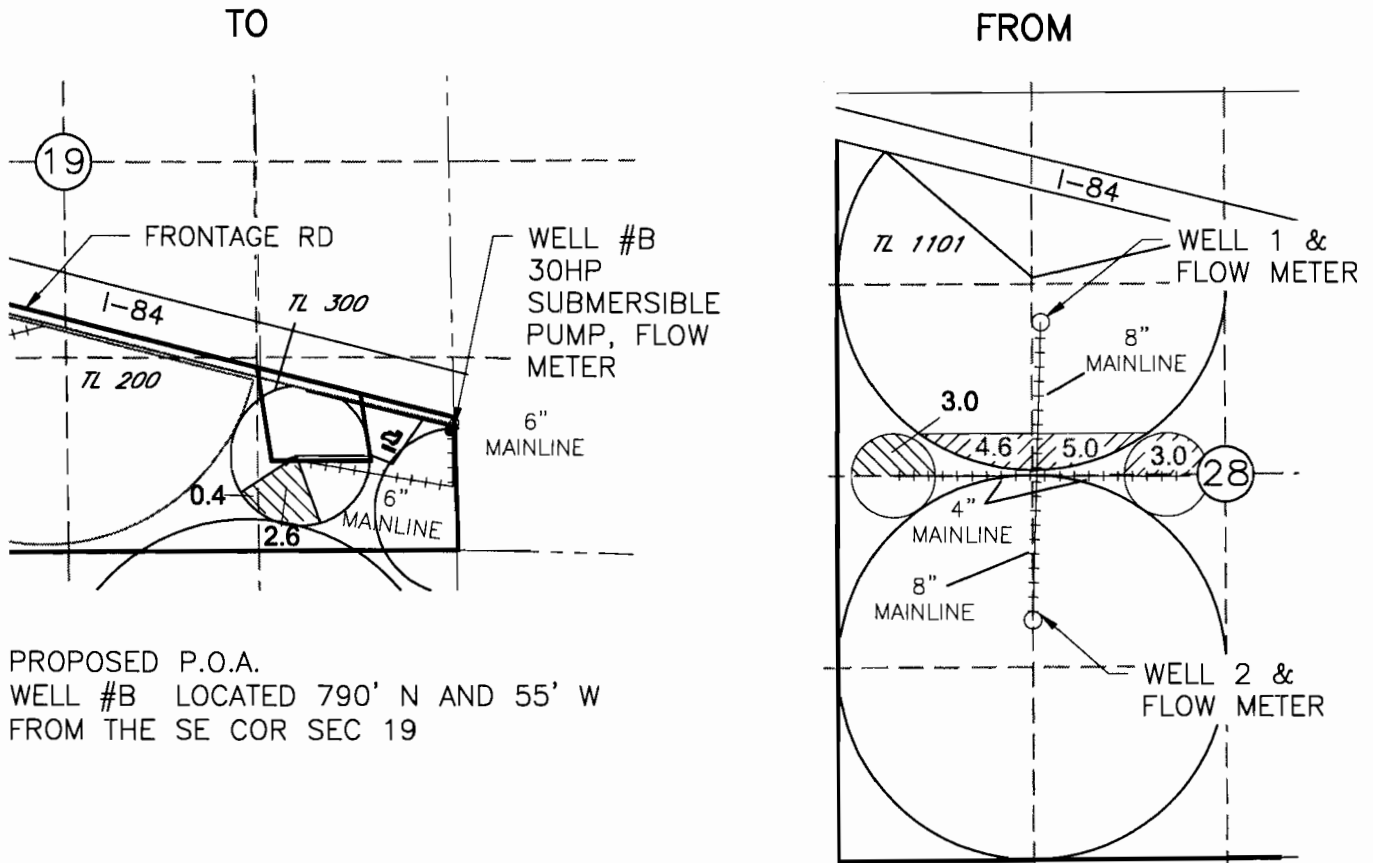

PROPOSED P.O.A.
 WELL #B LOCATED 790' N AND 55' W
 FROM THE SE COR SEC 19

AUTHORIZED P.O.A.
 WELL 1 LOCATED 3700' N AND 1390' E
 FROM THE SW COR SEC 28
 WELL 2 LOCATED 1650' N AND 1320' E
 FROM THE SW COR SEC 28

LEGEND

- ACRES TO BE TRANSFERRED PRIMARY CERT 60552
 SUPPLEMENTAL CERT 84119
- PORTION OF CERTIFICATE 60552 NOT INVOLVED IN THIS
 TRANSFER



NOTE:
 THE PURPOSE OF THIS MAP IS TO IDENTIFY THE APPROXIMATE LOCATION OF THE WATER
 RIGHT. IT IS NOT INTENDED TO PROVIDE INFORMATION RELATIVE TO THE LOCATION OF
 PROPERTY OWNERSHIP BOUNDARY LINES.

THE PIPE DISTRIBUTION SYSTEM IS BURIED PIPE. LOCATIONS AND SIZES ARE
 APPROXIMATE. THEY ARE BASED ON FARM MAPS, FIELD OBSERVATIONS AND DESCRIPTIONS
 PROVIDED BY OPERATIONS PERSONNEL.

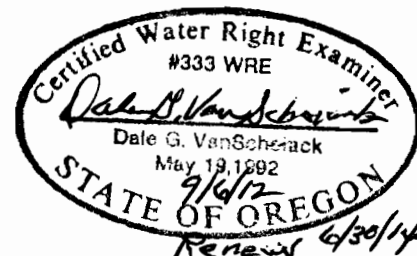

JEDEDIAH W. AYLETT
 TRANSFER APPLICATION MAP FOR A
 PORTION OF CERTIFICATE 53373 AND
 CERTIFICATE 84119
 T4N, R27E, W.M., MORROW COUNTY
 MAP 6 OF 7



RECEIVED BY OWRD

DEC 28 2012

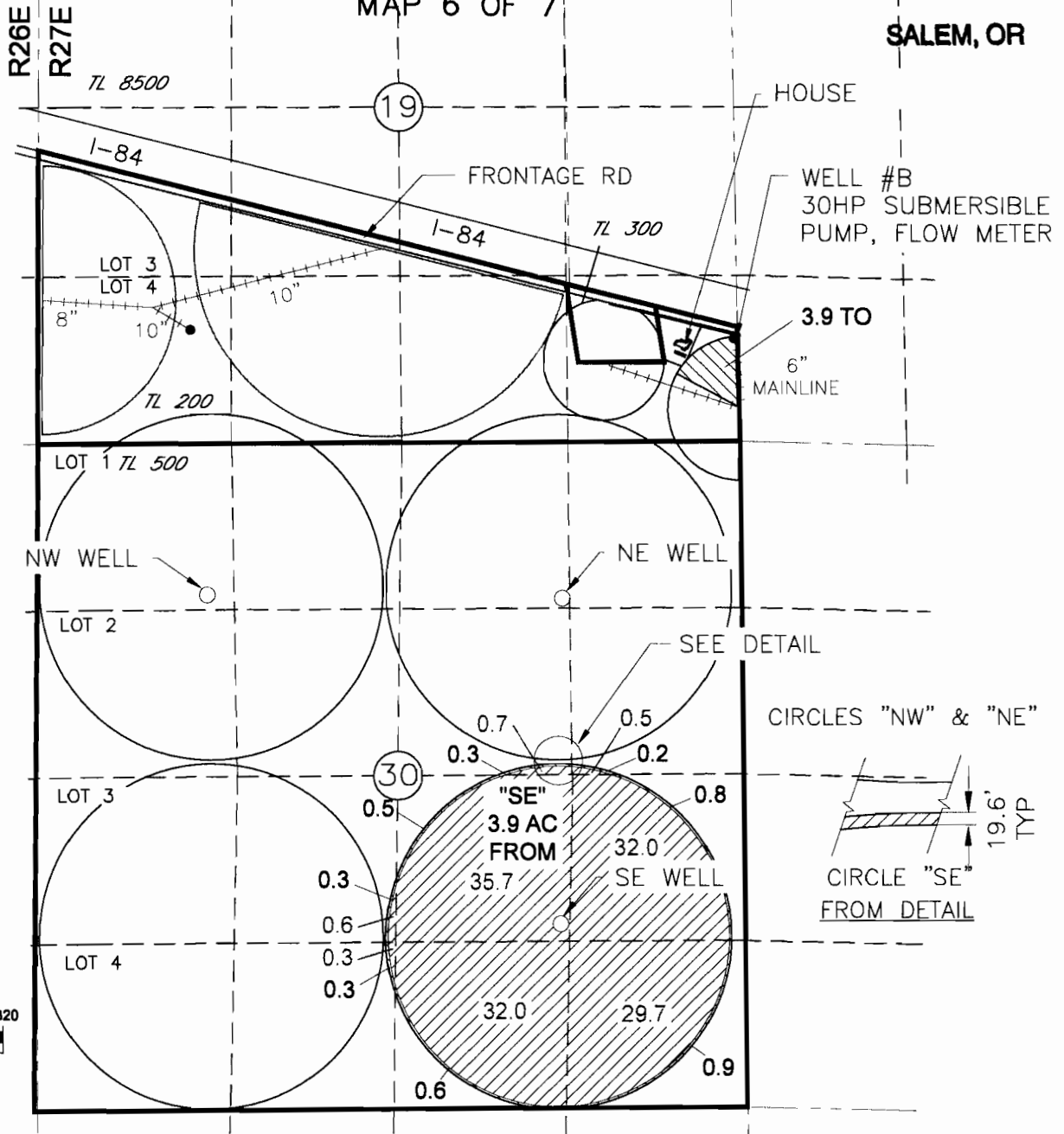
SALEM, OR



LEGEND

-  ACRES TO BE TRANSFERRED PRIMARY "NW & NE" CERT 53373
 SUPPLEMENTAL CERT 84119
-  PORTION OF CERTIFICATE 53373 NOT INVOLVED IN THIS
 TRANSFER

AUTHORIZED P.O.A.

SE WELL LOCATED 3830' S AND 4160' E FORM THE NW COR SEC 30
 PROPOSED P.O.A.

WELL #B LOCATED 790' N AND 55' W FROM THE SE COR SEC 29

NOTE:
 THE PURPOSE OF THIS MAP IS TO IDENTIFY THE APPROXIMATE LOCATION OF THE WATER
 RIGHT. IT IS NOT INTENDED TO PROVIDE INFORMATION RELATIVE TO THE LOCATION OF
 PROPERTY OWNERSHIP BOUNDARY LINES.

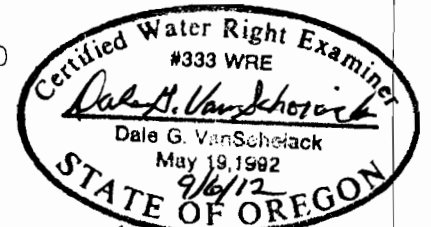

Revised 6/25/14

JEDEDIAH W. AYLETT
 TRANSFER APPLICATION MAP FOR A
 PORTION OF CERTIFICATE 44539 AND
 CERTIFICATE 84119
 T4N, R27E, W.M., MORROW COUNTY
 MAP 7 OF 7

RECEIVED BY OWRD

DEC 28 2012

HOUSE SALEM, OR

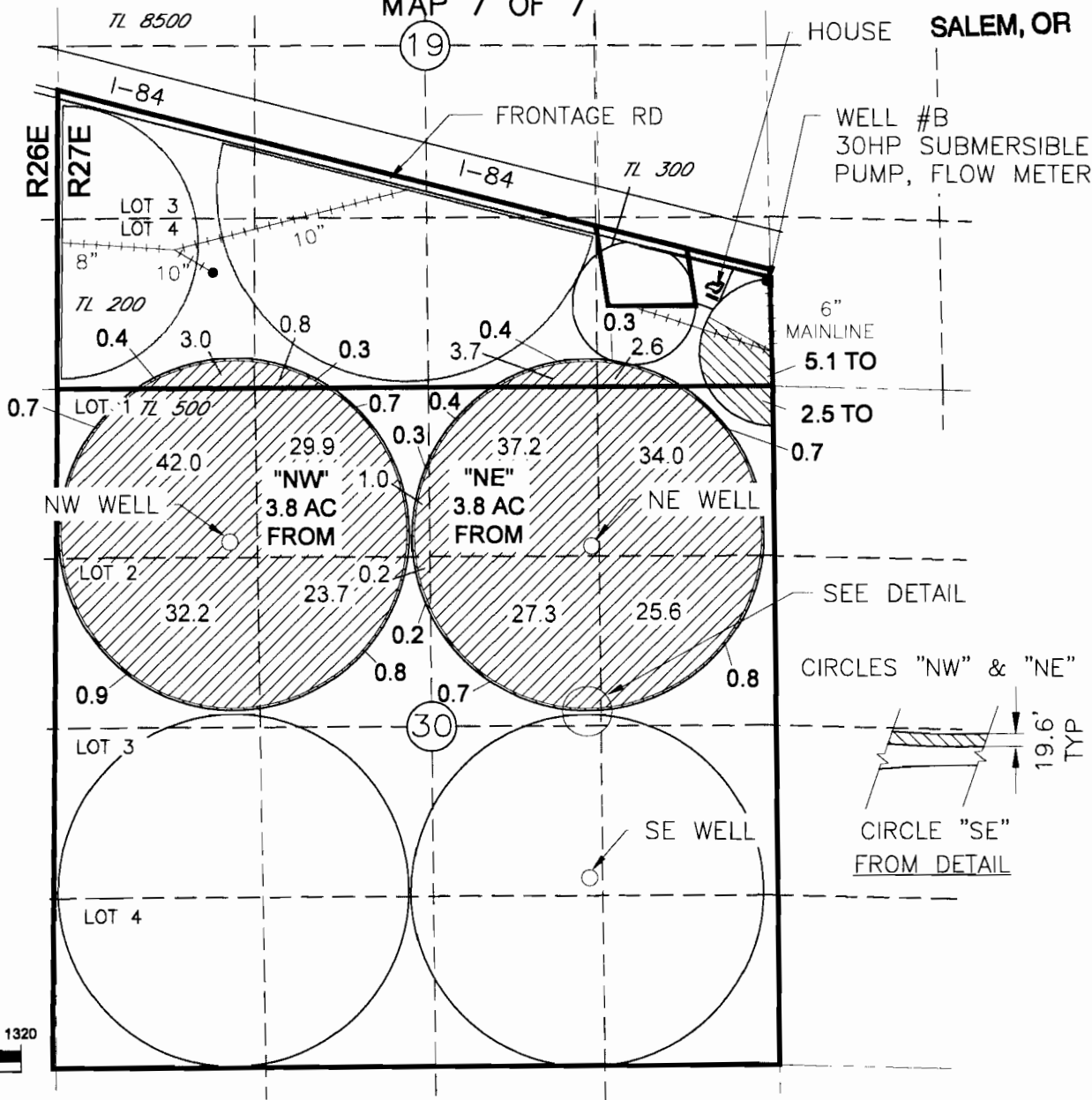



WELL #B
 30HP SUBMERSIBLE
 PUMP, FLOW METER

6" MAINLINE
 5.1 TO
 2.5 TO
 0.7

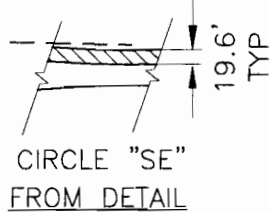
SEE DETAIL
 CIRCLES "NW" & "NE"



LEGEND

-  ACRES TO BE TRANSFERRED PRIMARY "NW & NE" CERT 44539
 SUPPLEMENTAL CERT 84119
-  PORTION OF CERTIFICATE 44539 NOT INVOLVED IN THIS
 TRANSFER

AUTHORIZED P.O.A.
 NE WELL LOCATED 1190' S AND 4170' E FROM THE NW COR SEC 30
 NW WELL LOCATED 1280' S AND 1350' E FROM THE NW COR SEC 30
 PROPOSED P.O.A.
 WELL #B LOCATED 790' N AND 55' W FROM THE SE COR SEC 29

NOTE:
 THE PURPOSE OF THIS MAP IS TO IDENTIFY THE APPROXIMATE LOCATION OF THE WATER
 RIGHT. IT IS NOT INTENDED TO PROVIDE INFORMATION RELATIVE TO THE LOCATION OF
 PROPERTY OWNERSHIP BOUNDARY LINES.

Certified Water Right Examiner
 #333 WRE
Alvin A. Schorack
 Dale G. VanDyke
 May 19, 1982
 9/25/12
 STATE OF OREGON
 Renew 6/30/14