

RECEIVED
 SEP 14 1973
 STATE ENGINEER
 SALEM, OREGON

RECEIVED
 JUN 15 1973
 STATE ENGINEER
 SALEM, OREGON

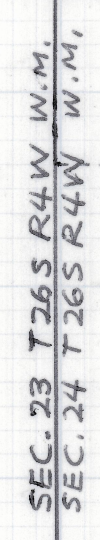

HOUSE NO
 100000000000

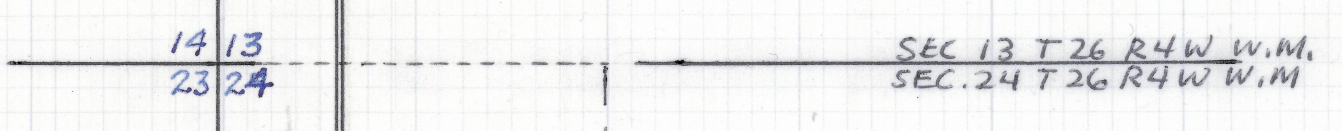
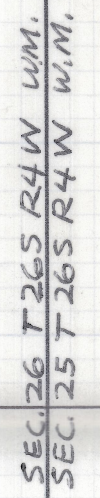
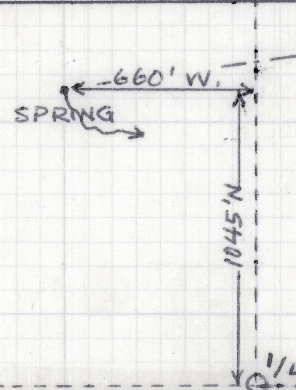
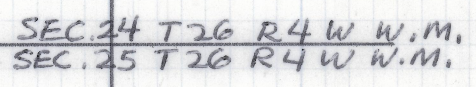
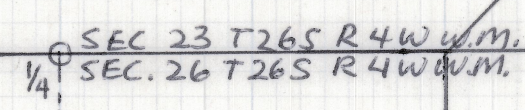
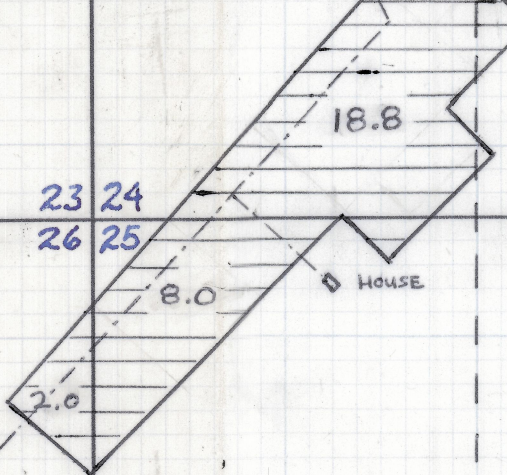
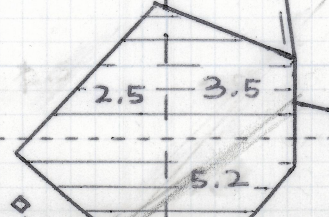
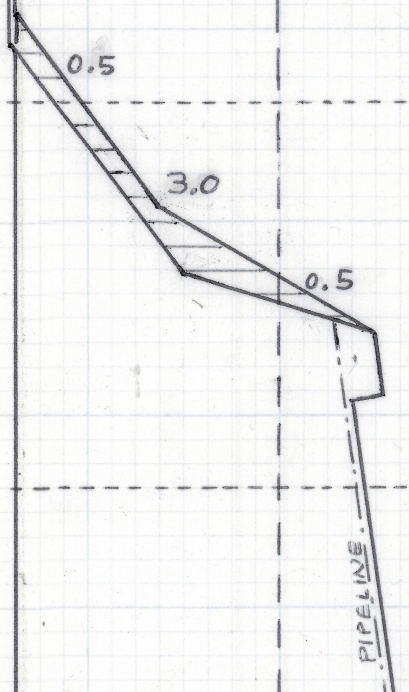

Application No. 50678
 Permit No. 37429

SCALE: 8" = 1 MILE