

WESTLAND IRRIGATION DISTRICT 540:580 NOTICE OF TRANSFER MAP PRIOR 2004 (GASS)

RECEIVED

DEC 30 2004

T3N, R29E WM

T3N, R29E WM

WATER RESOURCES DEPT
SALEM, OREGON

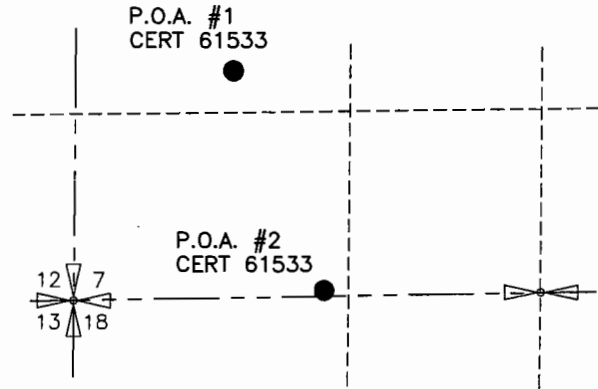
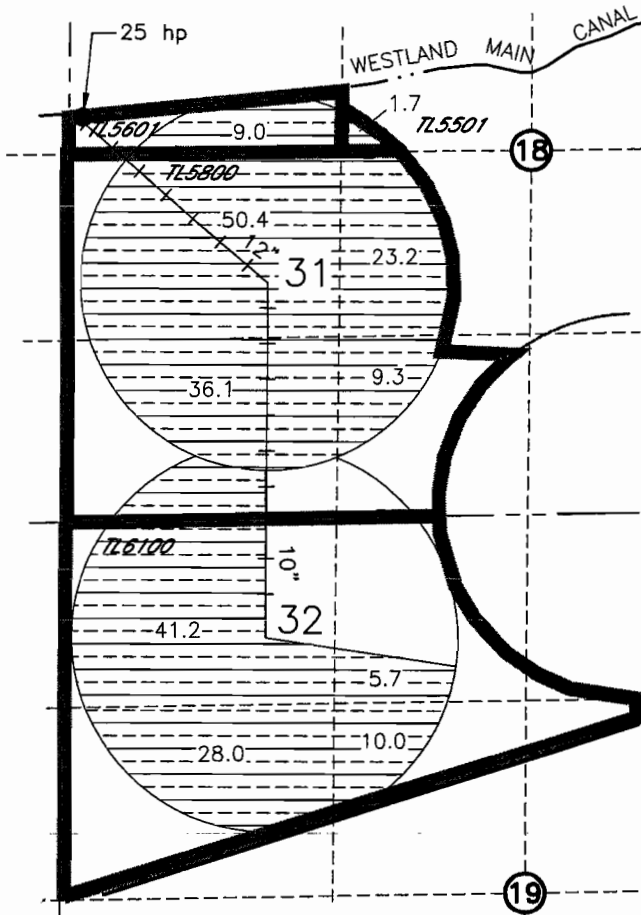

POINTS OF APPROPRIATION
WELL #1
LOCATED 1550'N AND 1470' E FROM
THE SW COR SEC 7
WELL #2
LOCATED 40'N AND 1490'W FROM
THE S 1/4 COR SEC 7

FROM

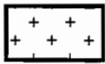

214.6ac PERMIT 25920 CERT 76050
NOTICE # PRIOR 2004 (GASS) 8

TO



214.6ac PERMIT 25920 CERT 76050
EXISTING PRIMARY PERMIT G-6095
CERT 61533 IN THIS AREA WILL
BECOME SUPPLEMENTAL
NOTICE # PRIOR 2004 (GASS) 8

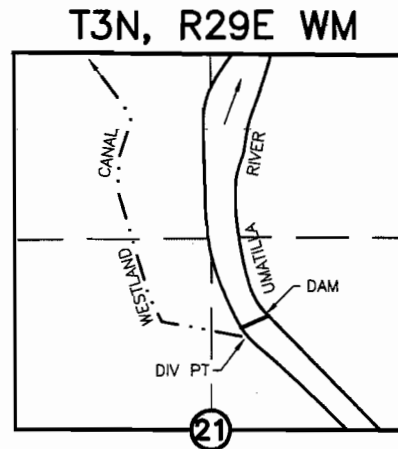

POINT OF DIVERSION
CERT'S 76717, 76799 & 76050
LOCATED N.76°45'56"E. 2913.19' FROM
W.1/4 COR. SEC 21



0 1320 2640



SCALE IN FEET

3/26/04

NOTE:
THE PURPOSE OF THIS MAP IS TO IDENTIFY THE APPROXIMATE LOCATION OF THE WATER RIGHT. IT IS NOT INTENDED TO PROVIDE INFORMATION RELATIVE TO THE LOCATION OF PROPERTY OWNERSHIP BOUNDARY LINES.

SCM Consultants, Inc.
A Tetra Tech Company

DRAWING: H:\CAD\AG\3522\077\3522077T04.dwg
PRINTED BY: RogerW on 12/16/04 01:44 PM

WESTLAND IRRIGATION DISTRICT 540:580 NOTICE OF TRANSFER MAP PRIOR 2004 (GASS)

T4N, R28E WM

T3N, R28E WM

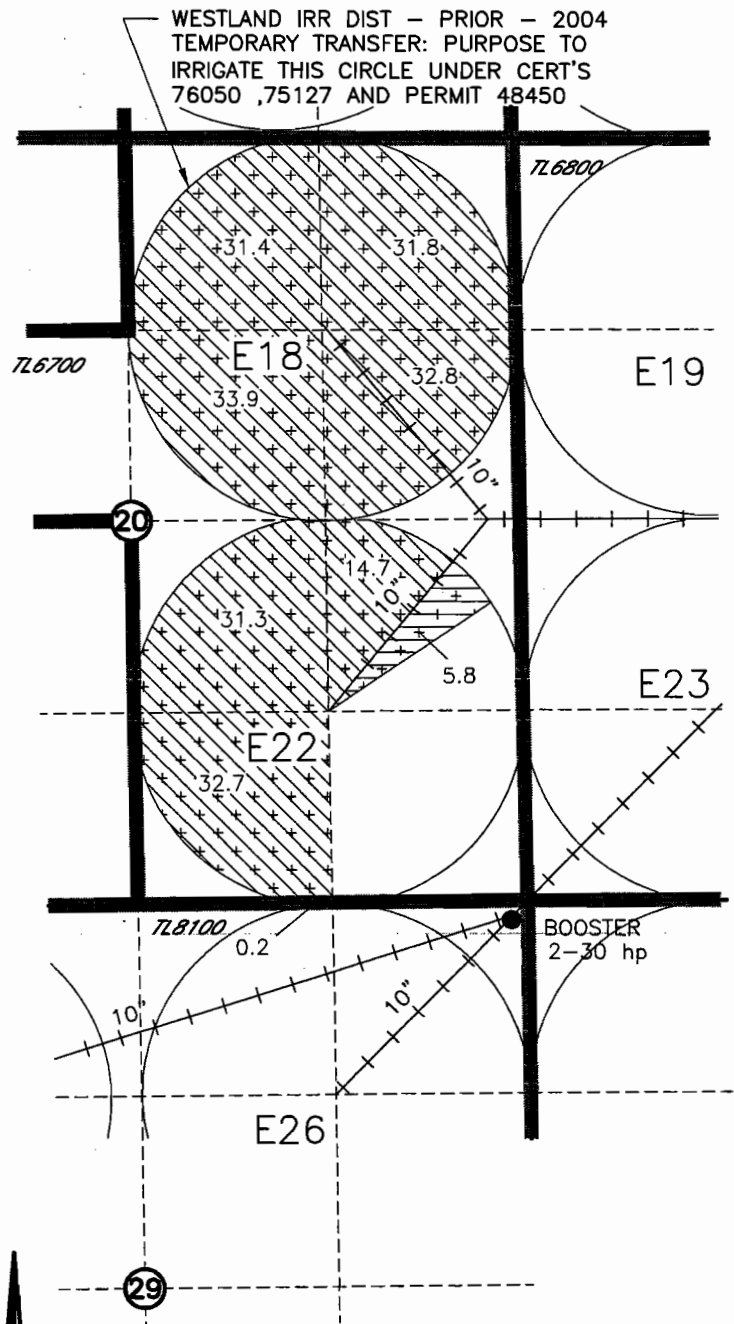
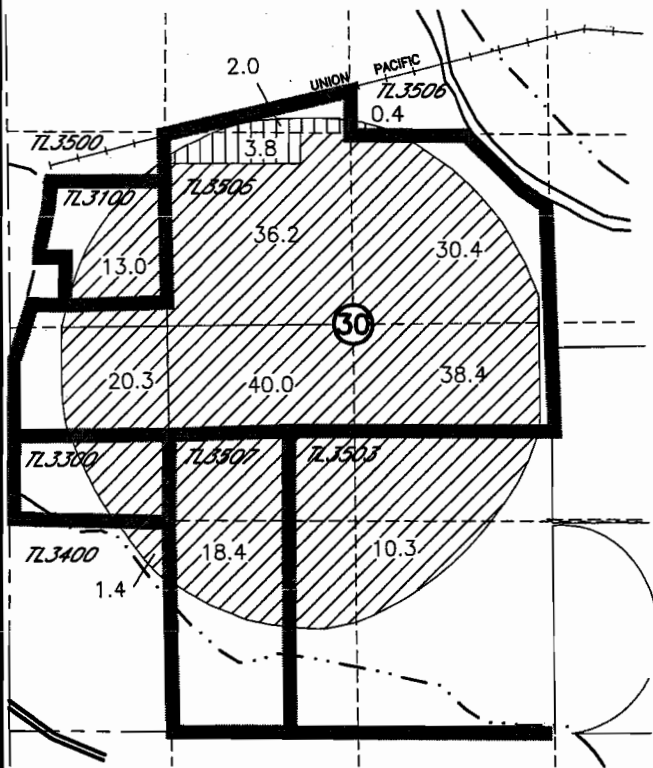

FROM

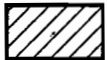

208.8ac CERT 76717 WID 1907 & CERT 79439
PERMIT 7400 MCKAY SUPPLEMENTAL
NOTICE # PRIOR 2004 (GASS) 5 & 7



5.8ac CERT 76799 WID 1961 PERMIT 27583
& 7400 MCKAY SUPPLEMENTAL
NOTICE # PRIOR 2004 (GASS) 6

TO



208.8ac CERT 76717 WID 1907 & CERT 79439
PERMIT 7400 MCKAY SUPPLEMENTAL
NOTICE # PRIOR 2004 (GASS) 5 & 7

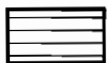

5.8ac CERT 76799 WID 1961 PERMIT 27583
& 7400 MCKAY SUPPLEMENTAL
NOTICE # PRIOR 2004 (GASS) 6



SCALE IN FEET

WESTLAND IRR DIST - PRIOR - 2004
TEMPORARY TRANSFER: PURPOSE TO
IRRIGATE THIS CIRCLE UNDER CERT'S
76050 ,75127 AND PERMIT 48450

BOOSTER
2-30 hp

NOTE:
THE PURPOSE OF THIS MAP IS TO IDENTIFY THE APPROXIMATE LOCATION
OF THE WATER RIGHT. IT IS NOT INTENDED TO PROVIDE INFORMATION
RELATIVE TO THE LOCATION OF PROPERTY OWNERSHIP BOUNDARY LINES.

SCM Consultants, Inc.
A Tetra Tech Company
DRAWING: H:\CAD\AG\3522\077\3522077T04.dwg
PRINTED BY: RogerW on 12/16/04 01:44 PM

3/26/04