

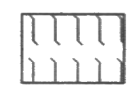
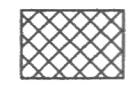

2010 BAKER PRODUCE SOUTH, INC
 TEMPORARY TRANSFER APPLICATION
 FROM MAP
 INVOLVING CERTIFICATES 68536,
 61848 & 61849
 T2&3N, R26E WM
 MORROW CO

FROM

-  191.3 AC PRIMARY COLUMBIA RIVER
CERT 68536
-  576.8 AC PRIMARY WELLS #1 & #3 CERT 61848
SUPPLEMENTAL COLUMBIA RIVER CERT 68536
SUPPLEMENTAL WELL #2 & #3 CERT 61849
-  225.2 AC PRIMARY WELLS #1 & #3 CERT 61848
SUPPLEMENTAL WELL #2 & #3 CERT 61849
- 993.3 AC
-  3.9 AC TEST PLOT AREA NOT INVOLVED IN THIS
TRANSFER

AUTHORIZED P.O.D.
 LOCATED S86°32'38"W 2841.57 FT FROM THE
 NE CORNER SEC 2, T4N, R25E WM

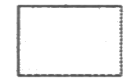
AUTHORIZED P.O.A.
 WELL #1 LOCATED 2470'N AND 2910'E FROM
 THE SW COR SEC 20 T2N, R26E, WM

WELL #2 LOCATED 100'S AND 1350'W FROM
 THE NE COR SEC 17 T2N, R26E, WM

WELL #3 LOCATED 30'S AND 30'W FROM THE
 E ¼ COR SEC 18 T2N, R26E, WM

T4N, R25E, WM

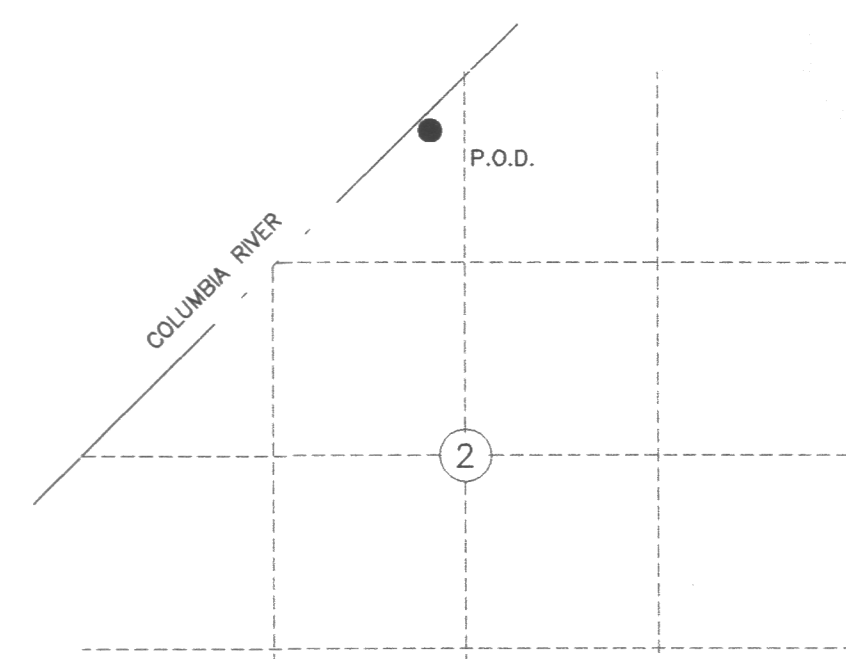

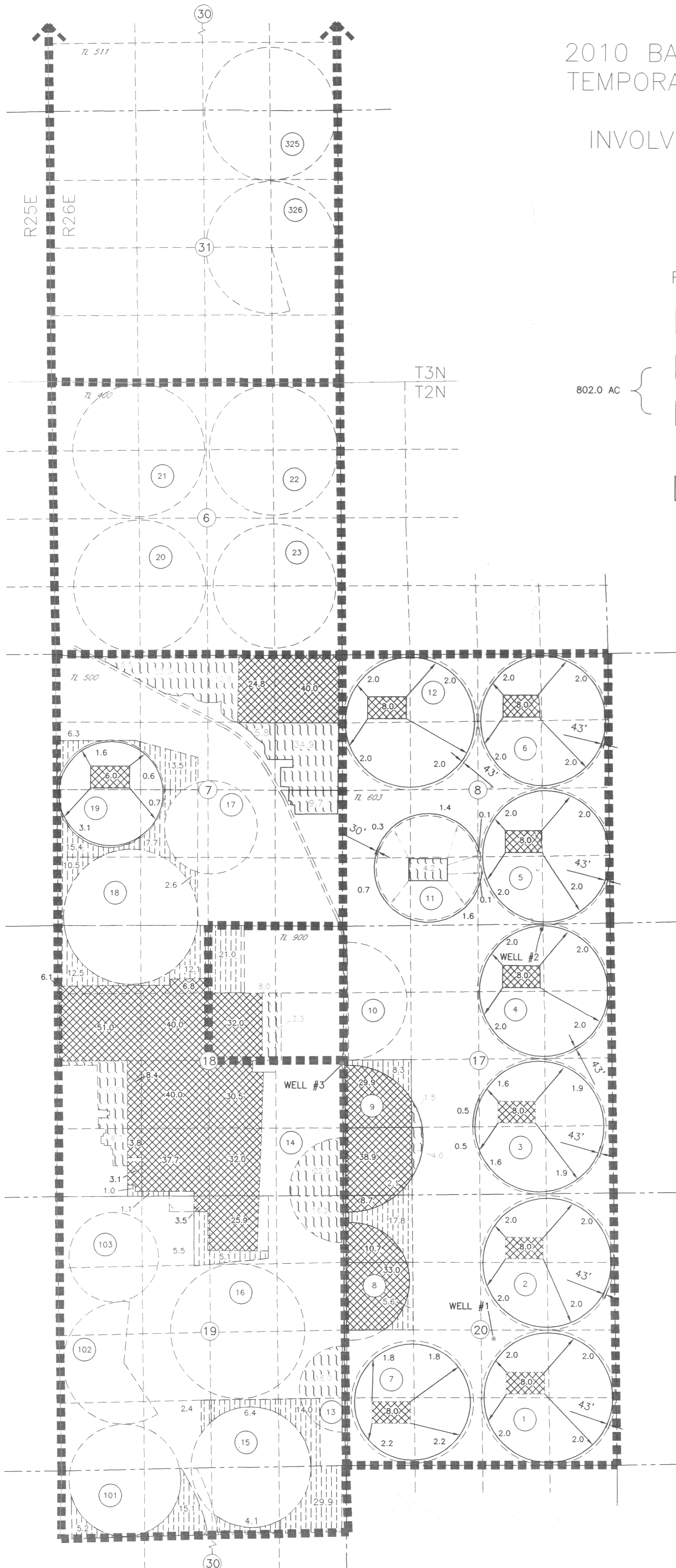
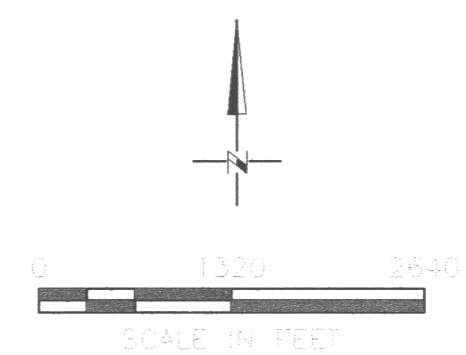

AUTHORIZED P.O.D. COLUMBIA RIVER
 LOCATED S86°32'38"W 2841.57 FT FROM THE
 NE CORNER SEC 2, T4N, R25E WM



REVISED
 JUN 16 2010
 APPROVED BY
 [Signature]

2010 BAKER PRODUCE SOUTH, INC
 TEMPORARY TRANSFER APPLICATION
 TO MAP
 INVOLVING CERTIFICATES 68536,
 61848 & 61849
 T2&3N, R26E WM
 MORROW CO

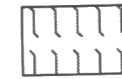
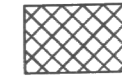
TO

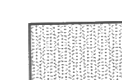
-  191.3 AC PRIMARY COLUMBIA RIVER
CERT 68536
-  576.8 AC PRIMARY WELLS #1 & #3 CERT 61848
SUPPLEMENTAL COLUMBIA RIVER CERT 68536
SUPPLEMENTAL WELL #2 & #3 CERT 61849
-  225.2 AC PRIMARY WELLS #1 & #3 CERT 61848
SUPPLEMENTAL WELL #2 & #3 CERT 61849
- 993.3 AC
-  3.9 AC TEST PLOT AREA NOT INVOLVED IN THIS
TRANSFER

AUTHORIZED P.O.D.
 LOCATED S86°32'38"W 2841.57 FT FROM THE
 NE CORNER SEC 2, T4N, R25E WM

AUTHORIZED P.O.A.
 WELL #1 LOCATED 2470'N AND 2910'E FROM
 THE SW COR SEC 20 T2N, R26E, WM

WELL #2 LOCATED 100'S AND 1350'W FROM
 THE NE COR SEC 17 T2N, R26E, WM

WELL #3 LOCATED 30'S AND 30'W FROM THE
 E ¼ COR SEC 18 T2N, R26E, WM

DRIP LINE DETAIL

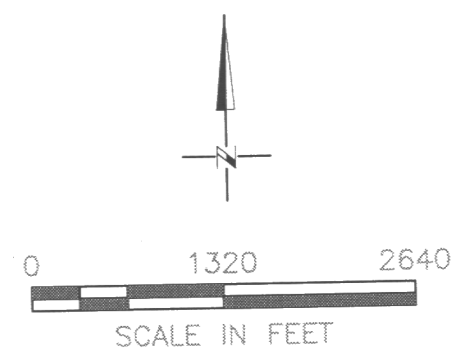
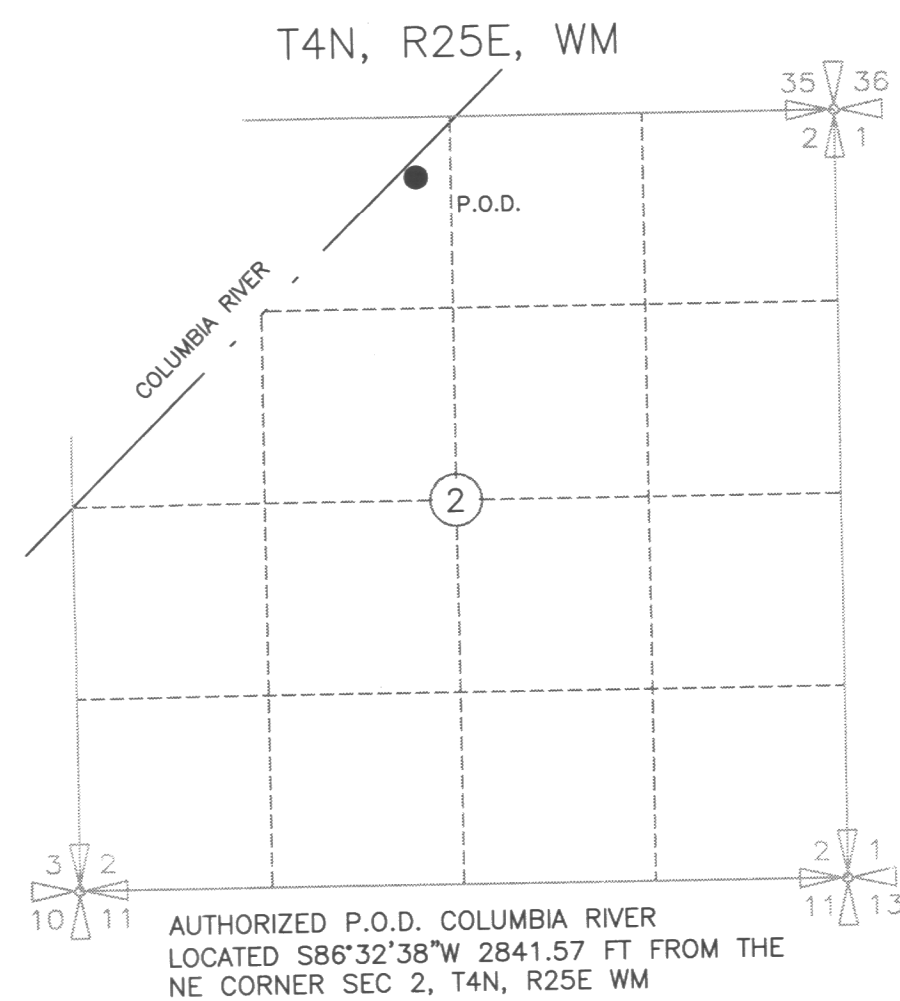
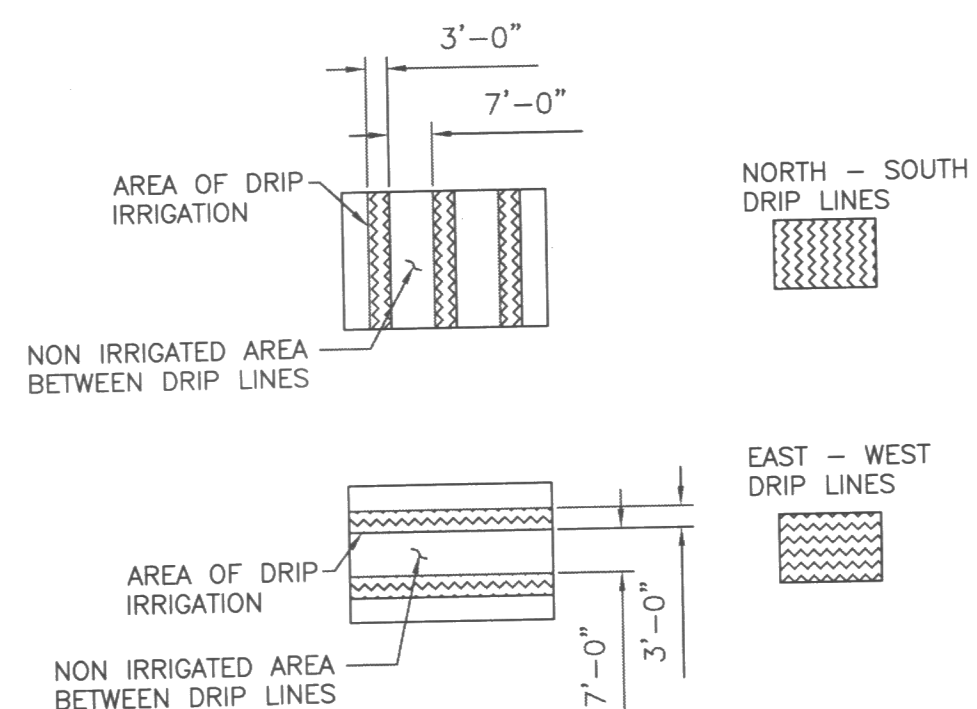

NOTE:
 THE PURPOSE OF THIS MAP IS TO IDENTIFY THE APPROXIMATE LOCATION
 OF THE WATER RIGHT. IT IS NOT INTENDED TO PROVIDE INFORMATION
 RELATIVE TO THE LOCATION OF PROPERTY OWNERSHIP BOUNDARY LINES.

RECEIVED
 JUN 16 2010
 WATER RIGHTS DIVISION
 MARIETTA, OHIO