

MEADOWBROOK C/O FRANK TIEGS
 2024 TEMPORARY TRANSFER APPLICATION MAP
 INVOLVING CERTIFICATE 82489
 AND PERMITS S-54980 & S-55268
 T1&T2S, R25E WM
 MORROW CO
 FROM MAP (1 OF 6)

Received by OWRD

MAR 22 2024

Salem, OR

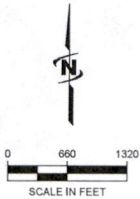
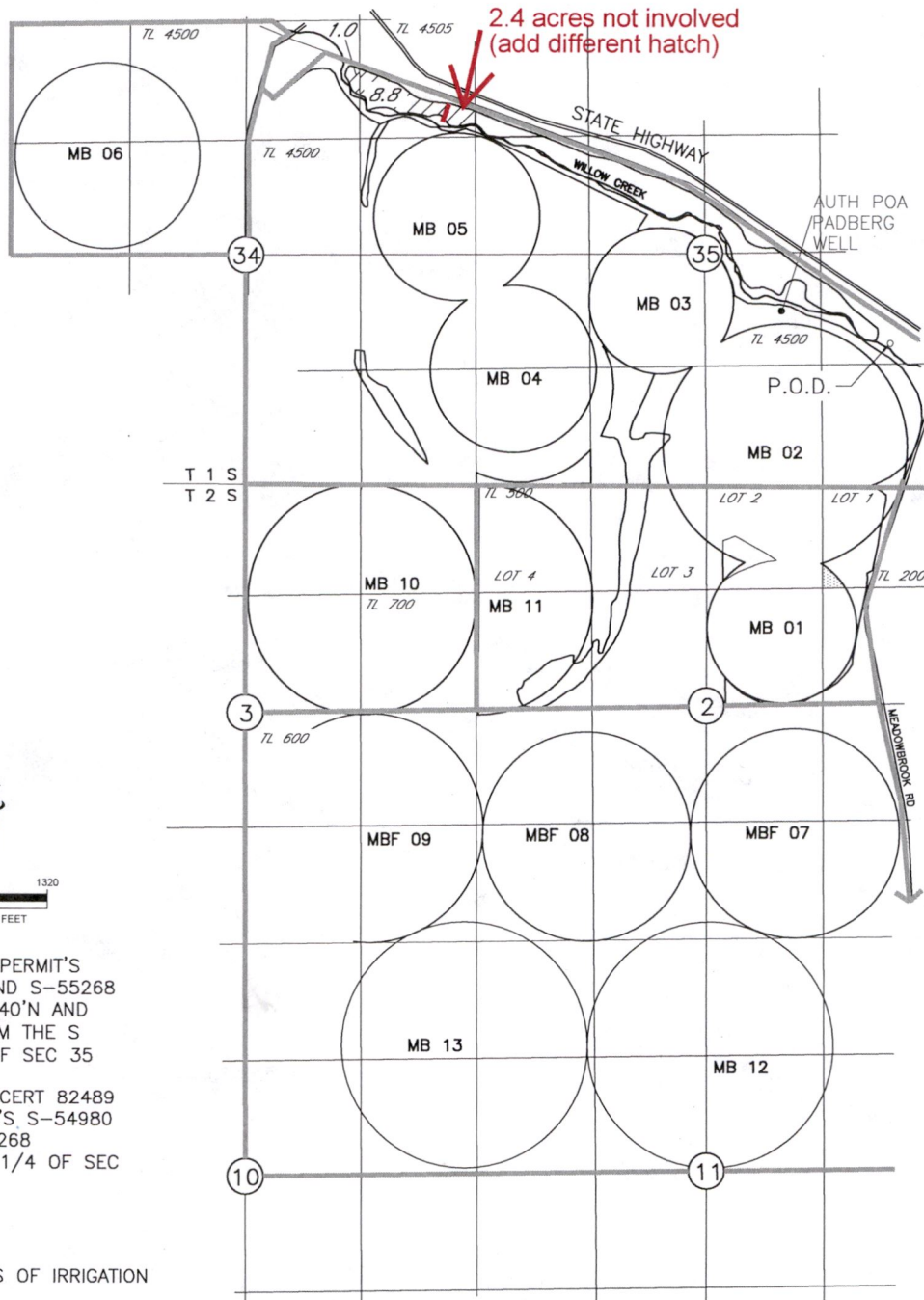

P.O.D. FOR PERMIT'S
 S-54980 AND S-55268
 LOCATED 1540'N AND
 2100'E FROM THE S
 1/4, COR OF SEC 35

P.O.D. FOR CERT 82489
 AND PERMIT'S S-54980
 AND S-55268
 N 1/2, NE 1/4 OF SEC
 34

AREAS OF IRRIGATION



9.8 AC
 CERTIFICATE 82489 PRIMARY,
 PERMIT'S S-54980 AND S-55268 SUPPLEMENTAL



2.4 AC Not involved in this transfer
 Cert 82486, Primary
 Permits S-54980 and S-55268 Supplemental

NOTE:
 THE PURPOSE OF THIS MAP IS TO IDENTIFY THE APPROXIMATE LOCATION
 OF THE WATER RIGHT. IT IS NOT INTENDED TO PROVIDE INFORMATION
 RELATIVE TO THE LOCATION OF PROPERTY OWNERSHIP BOUNDARY LINES.

DRAWING: \\Kwfiles\Public\Project\30-08-016 - Porfly Water Rights Consulting\--00 Misc Engineering\Cad\TIEGS\30-08-016 24 ME TT.dwg
 PRINTED BY: kvaldovinos on 02/05/24 12:26 PM

MEADOWBROOK C/O FRANK TIEGS
 2024 TEMPORARY TRANSFER APPLICATION MAP
 INVOLVING CERTIFICATE 30021
 AND PERMITS S-54980 & S-55268
 T1&T2S, R25E WM
 MORROW CO
 FROM MAP (2 OF 6)

Received by OWRD

MAR 22 2024

Salem, OR

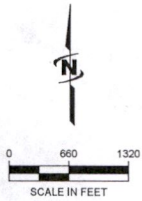
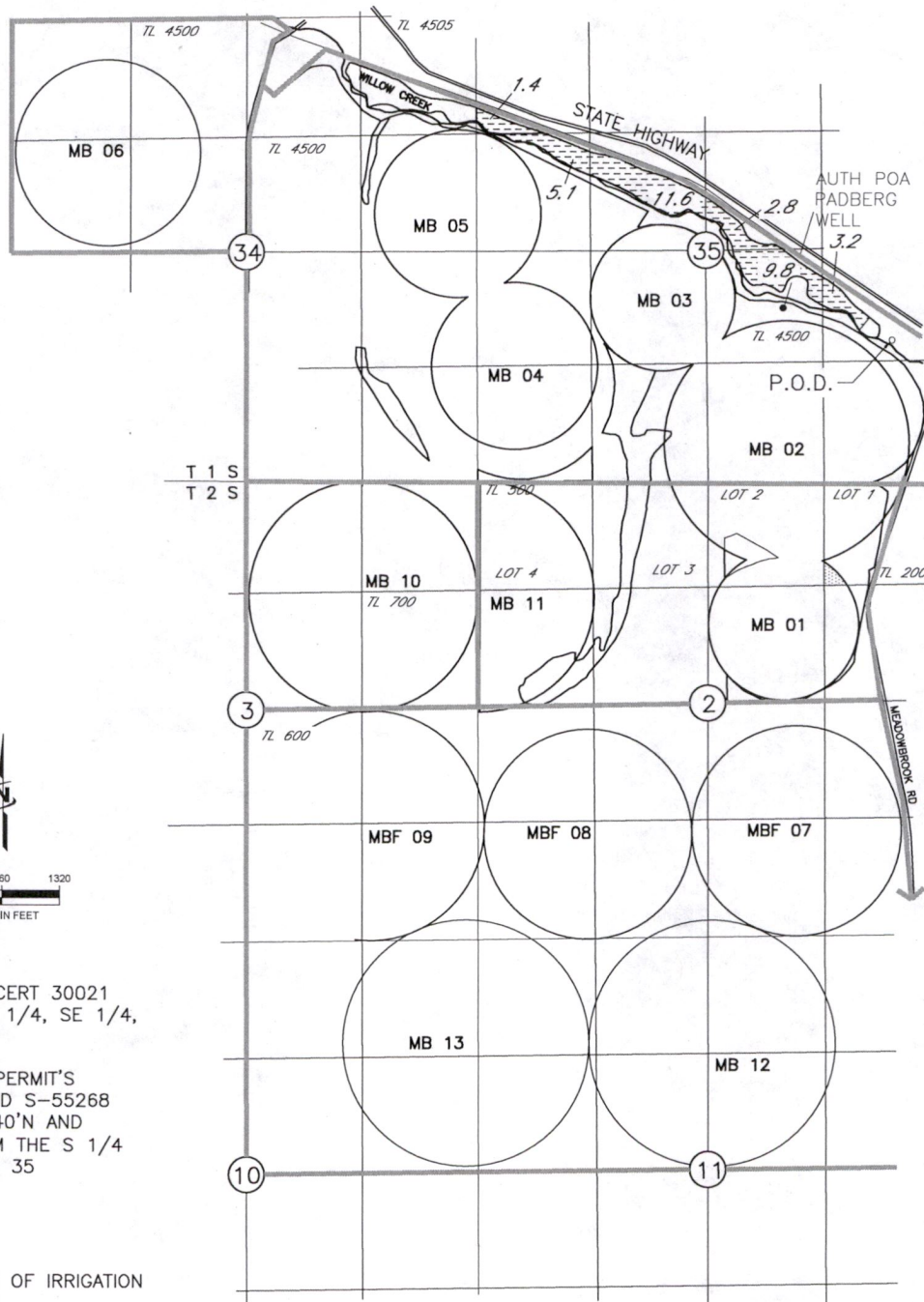

P.O.D. FOR CERT 30021
 LOCATED NE 1/4, SE 1/4,
 SEC 35

P.O.D. FOR PERMIT'S
 S-54980 AND S-55268
 LOCATED 1540'N AND
 2100'E FROM THE S 1/4
 COR OF SEC 35

AREAS OF IRRIGATION

 33.9 AC
 CERTIFICATE 30021 PRIMARY, PERMIT'S S-54980 &
 S-55268 SUPPLEMENTAL

NOTE:
 THE PURPOSE OF THIS MAP IS TO IDENTIFY THE APPROXIMATE LOCATION
 OF THE WATER RIGHT. IT IS NOT INTENDED TO PROVIDE INFORMATION
 RELATIVE TO THE LOCATION OF PROPERTY OWNERSHIP BOUNDARY LINES.

DRAWING: \\k\kfiles\Public\Project\30-08-016 - Porfily Water Rights Consulting\--00 Misc Engineering\Cad\TIEGS\30-08-016 24 ME TT.dwg
 PRINTED BY: kvaldovinos on 02/05/24 12:27 PM

MEADOWBROOK C/O FRANK TIEGS
 2024 TEMPORARY TRANSFER APPLICATION MAP
 INVOLVING CERTIFICATE 94969
 AND PERMITS S-54980 & S-55268
 T1&T2S, R25E WM
 MORROW CO
 FROM MAP (3 OF 6)

Received by OWRD

MAR 22 2024

Salem, OR

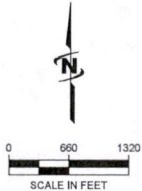
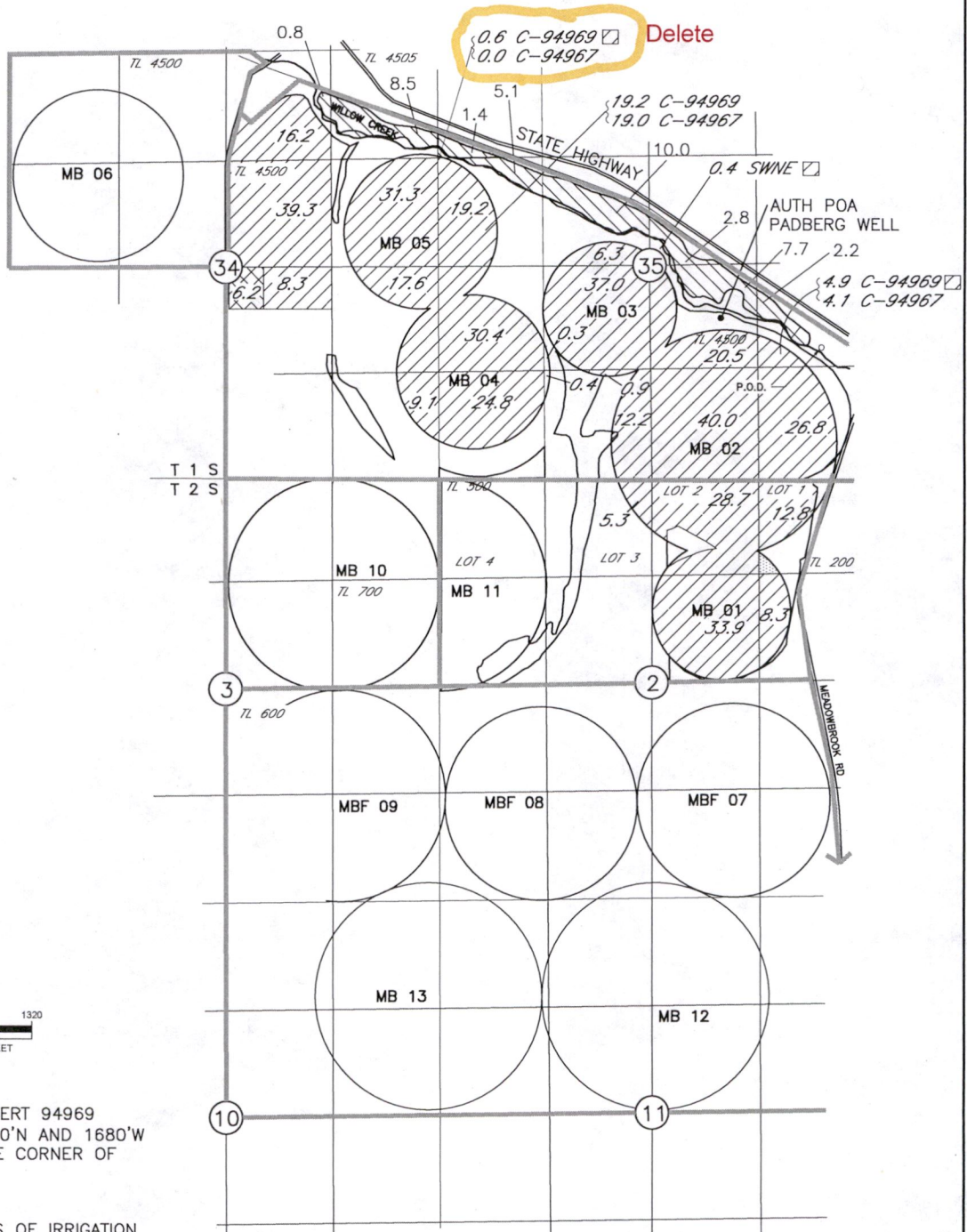

AUTHORIZED
 P.O.A. FOR CERT 94969
 LOCATED 1810'N AND 1680'W
 FROM THE SE CORNER OF
 SEC 35

- AREAS OF IRRIGATION
- 434.9 AC PRIMARY
 CERTIFICATE 94969 PRIMARY, & PERMIT'S
 S-54980 & S-55268 SUPPLEMENTAL
 - 38.5 AC CERTIFICATE 94969 SUPPLEMENTAL
 - 6.2 AC
 CERTIFICATE 94969 PRIMARY NOT INVOLVED
 IN THIS TRANSFER

NOTE:
 THE PURPOSE OF THIS MAP IS TO IDENTIFY THE APPROXIMATE LOCATION
 OF THE WATER RIGHT. IT IS NOT INTENDED TO PROVIDE INFORMATION
 RELATIVE TO THE LOCATION OF PROPERTY OWNERSHIP BOUNDARY LINES.
 DRAWING: \\wfiles\Public\Project\30-08-016 - Porfly Water Rights Consulting\--00 Misc Engineering\Cad\TIEGS\30-08-016 24 ME TT.dwg
 PRINTED BY: kvaldovinos on 02/05/24 12:36 PM

MEADOWBROOK C/O FRANK TIEGS
 2024 TEMPORARY TRANSFER APPLICATION MAP
 INVOLVING CERTIFICATE 94967
 AND PERMITS S-54980 & S-55268
 T1&T2S, R25E WM
 MORROW CO
 FROM MAP (4 OF 6)

Received by OWRD

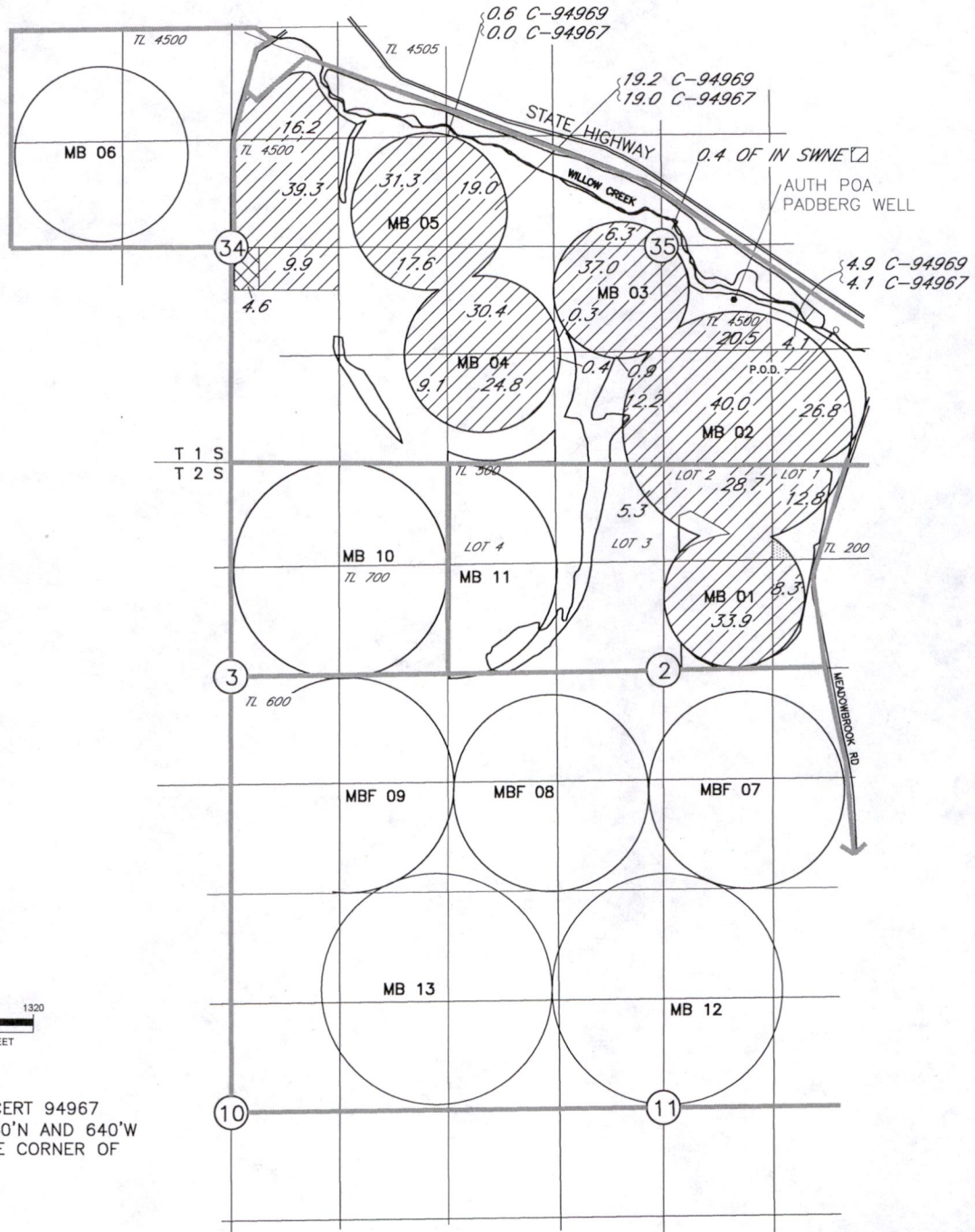

MAR 22 2024

Salem, OR



AUTHORIZED
 P.O.D. FOR CERT 94967
 LOCATED 1550'N AND 640'W
 FROM THE SE CORNER OF
 SEC 35

AREAS OF IRRIGATION

	4.35.5 AC CERTIFICATE'S 94967 SUPPLEMENTAL & PERMIT'S S-54980 & S-55268 SUPPLEMENTAL		4.6 AC CERTIFICATE'S 94967 NOT INVOLVED IN THIS TRANSFER
---	--	---	--

NOTE:
 THE PURPOSE OF THIS MAP IS TO IDENTIFY THE APPROXIMATE LOCATION
 OF THE WATER RIGHT. IT IS NOT INTENDED TO PROVIDE INFORMATION
 RELATIVE TO THE LOCATION OF PROPERTY OWNERSHIP BOUNDARY LINES.
 DRAWING: \\kwlfiles\Public\Project\30-08-016 - Parfly Water Rights Consulting\00 Misc Engineering\Cad\TIEGS\30-08-016 24 ME TT.dwg
 PRINTED BY: kvoldovinos on 02/05/24 12:36 PM

MEADOWBROOK C/O FRANK TIEGS
 2024 TEMPORARY TRANSFER APPLICATION MAP
 INVOLVING CERTIFICATE 96377
 AND PERMITS S-54980 & S-55268
 T1&T2S, R25E WM
 MORROW CO
 FROM MAP (5 OF 6)

Received by OWRD

MAR 22 2024

Salem, OR

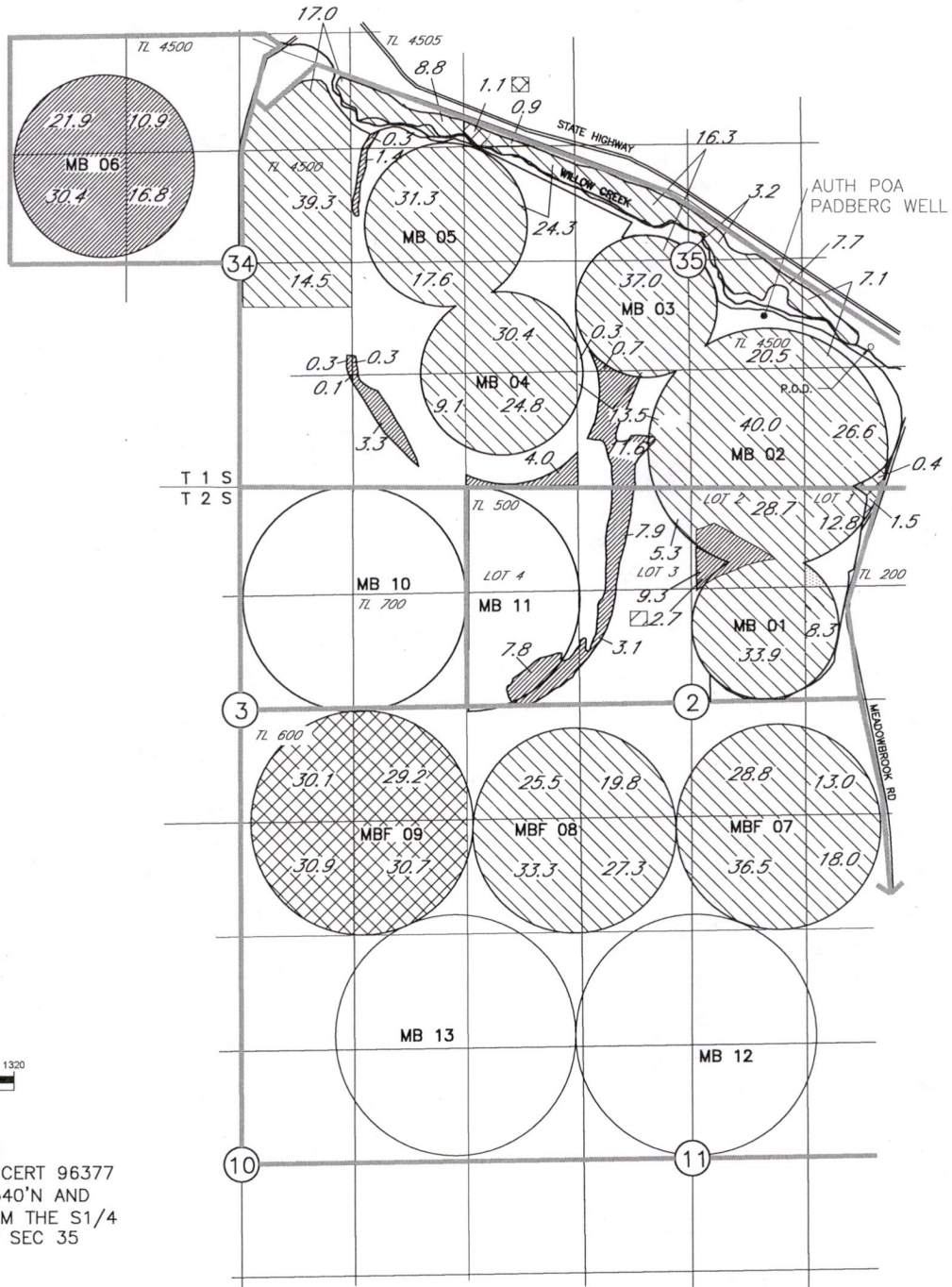

AUTHORIZED
 P.O.A. FOR CERT 96377
 LOCATED 1540'N AND
 2100'E FROM THE S1/4
 CORNER OF SEC 35

AREAS OF IRRIGATION

- 130.1 AC CERTIFICATE 96377 PRIMARY, SUPPLEMENTAL PERMIT'S S-54980 AND S-55268
- 686.0 AC SUPPLEMENTAL
- 121.0 AC SUPPLEMENTAL NOT INVOLVED IN THIS TRANSFER

NOTE:
 THE PURPOSE OF THIS MAP IS TO IDENTIFY THE APPROXIMATE LOCATION OF THE WATER RIGHT. IT IS NOT INTENDED TO PROVIDE INFORMATION RELATIVE TO THE LOCATION OF PROPERTY OWNERSHIP BOUNDARY LINES.
 DRAWING: \\wv\files\Public\Project\30-08-016 - Porifly Water Rights Consulting\--00 Misc Engineering\Cad\TIEGS\30-08-016 24 ME TT.dwg
 PRINTED BY: kvoldovinos on 02/05/24 12:36 PM

MEADOWBROOK C/O FRANK TIEGS
 2024 TEMPORARY TRANSFER APPLICATION MAP
 INVOLVING CERTIFICATE 94970
 AND PERMITS S-54980 & S-55268
 T1&T2S, R25E WM
 MORROW CO
 FROM MAP (6 OF 6)

Received by OWRD

MAR 22 2024

Salem, OR

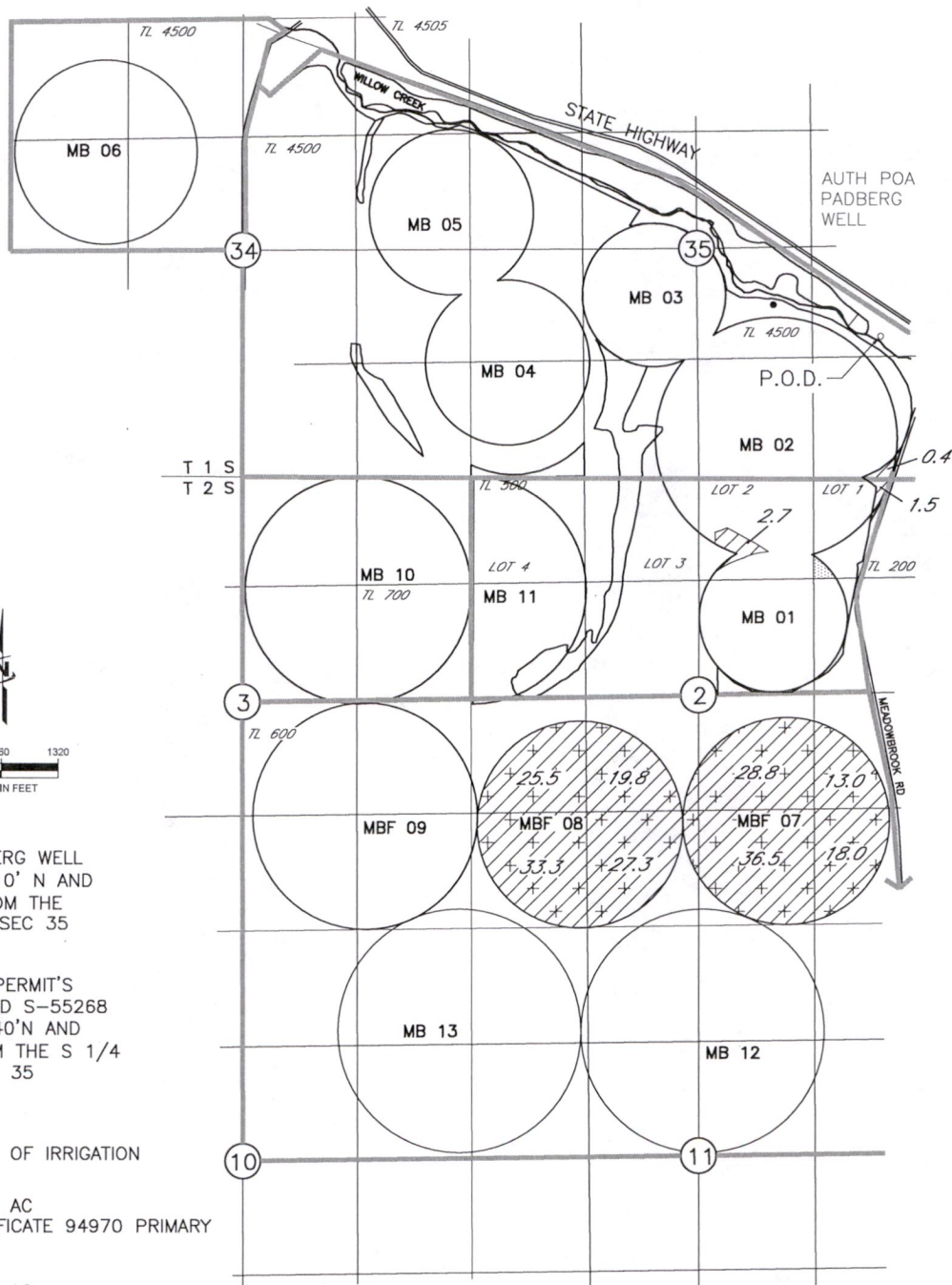

P.O.A. PADBERG WELL
 LOCATED 1810' N AND
 1680' W FROM THE
 SE COR OF SEC 35

P.O.D. FOR PERMIT'S
 S-54980 AND S-55268
 LOCATED 1540' N AND
 2100' E FROM THE S 1/4
 COR OF SEC 35

AREAS OF IRRIGATION

 206.8 AC
 CERTIFICATE 94970 PRIMARY

 202.2 AC
 S-55268 SUPPLEMENTAL

NOTE:
 THE PURPOSE OF THIS MAP IS TO IDENTIFY THE APPROXIMATE LOCATION
 OF THE WATER RIGHT. IT IS NOT INTENDED TO PROVIDE INFORMATION
 RELATIVE TO THE LOCATION OF PROPERTY OWNERSHIP BOUNDARY LINES.

MEADOWBROOK C/O FRANK TIEGS
 2024 TEMPORARY TRANSFER APPLICATION MAP
 INVOLVING CERTIFICATE 82489
 AND PERMITS S-54980 & S-55268
 T1&T2S, R25E WM
 MORROW CO
 TO MAP (1 OF 6)

Received by OWRD
 MAR 22 2024
 Salem, OR

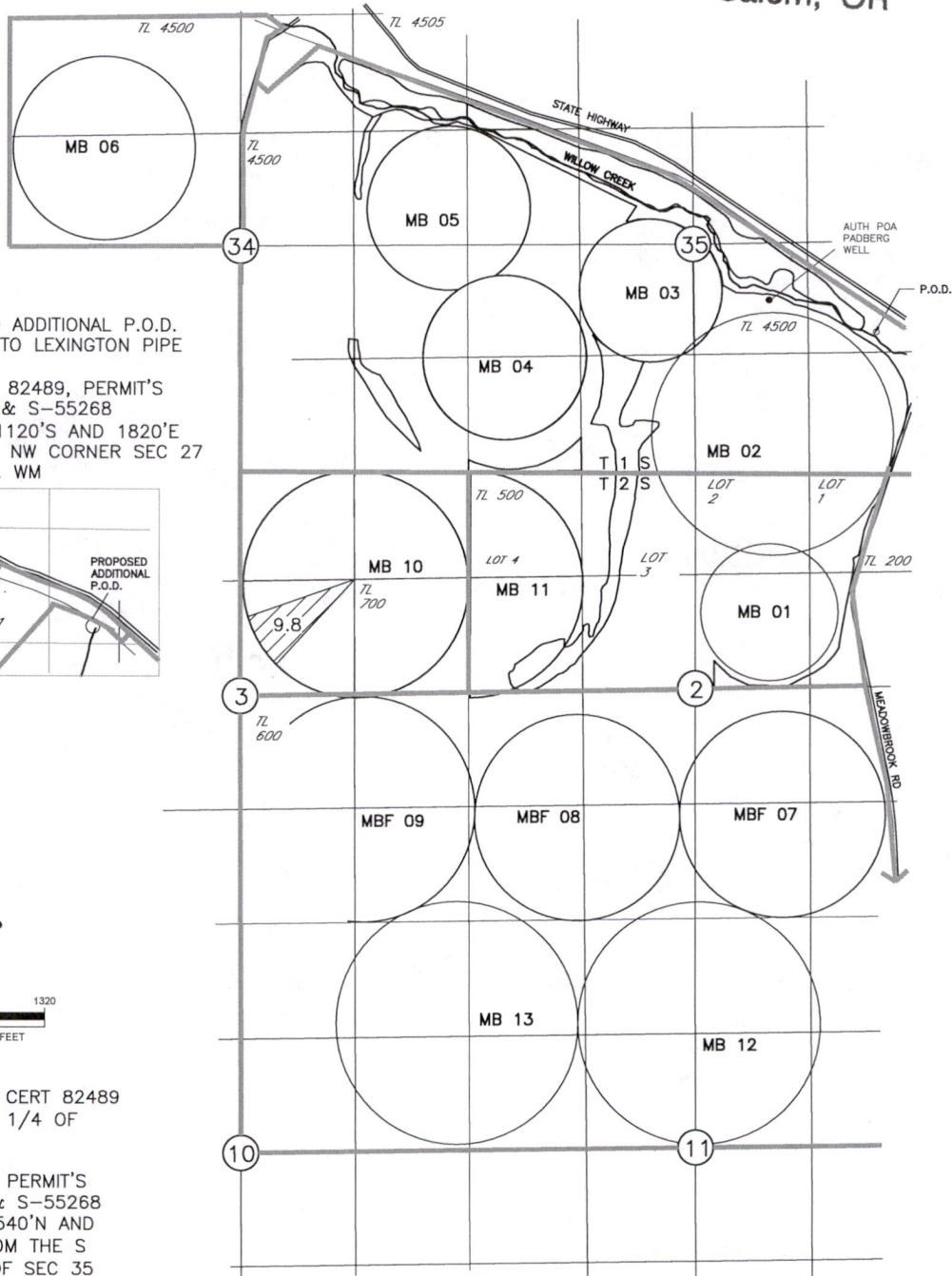

PROPOSED ADDITIONAL P.O.D.
 HEPPNER TO LEXINGTON PIPE
 LINE
 FOR CERT 82489, PERMIT'S
 S-54980 & S-55268
 LOCATED 1120'S AND 1820'E
 FROM THE NW CORNER SEC 27
 T2S R26E. WM

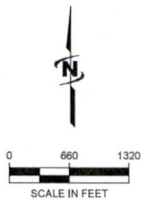
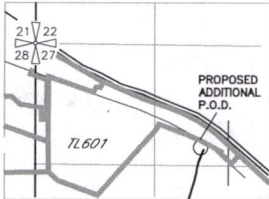

P.O.D. FOR CERT 82489
 N 1/2, NE 1/4 OF
 SEC 34

P.O.D. FOR PERMIT'S
 S-54980 & S-55268
 LOCATED 1540'N AND
 2100'E FROM THE S
 1/4 COR OF SEC 35

AREAS OF IRRIGATION



9.8 AC

CERTIFICATE 82489 PRIMARY, PERMIT'S S-54980 &
 S-55268 SUPPLEMENTAL

NOTE:

THE PURPOSE OF THIS MAP IS TO IDENTIFY THE APPROXIMATE LOCATION
 OF THE WATER RIGHT. IT IS NOT INTENDED TO PROVIDE INFORMATION
 RELATIVE TO THE LOCATION OF PROPERTY OWNERSHIP BOUNDARY LINES.

DRAWING: \\kwd\files\Public\Project\30-08-016 - Porifly Water Rights Consulting\00 Misc Engineering\Cad\TIEGS\30-08-016 24 ME TT.dwg

PRINTED BY: kvoldovinos on 02/05/24 12:38 PM

MEADOWBROOK C/O FRANK TIEGS
 2024 TEMPORARY TRANSFER APPLICATION MAP
 INVOLVING CERTIFICATE 30021
 AND PERMITS S-54980 & S-55268
 T1&T2S, R25E WM
 MORROW CO
 TO MAP (2 OF 6)

Received by OWRD

MAR 22 2024

Salem, OR

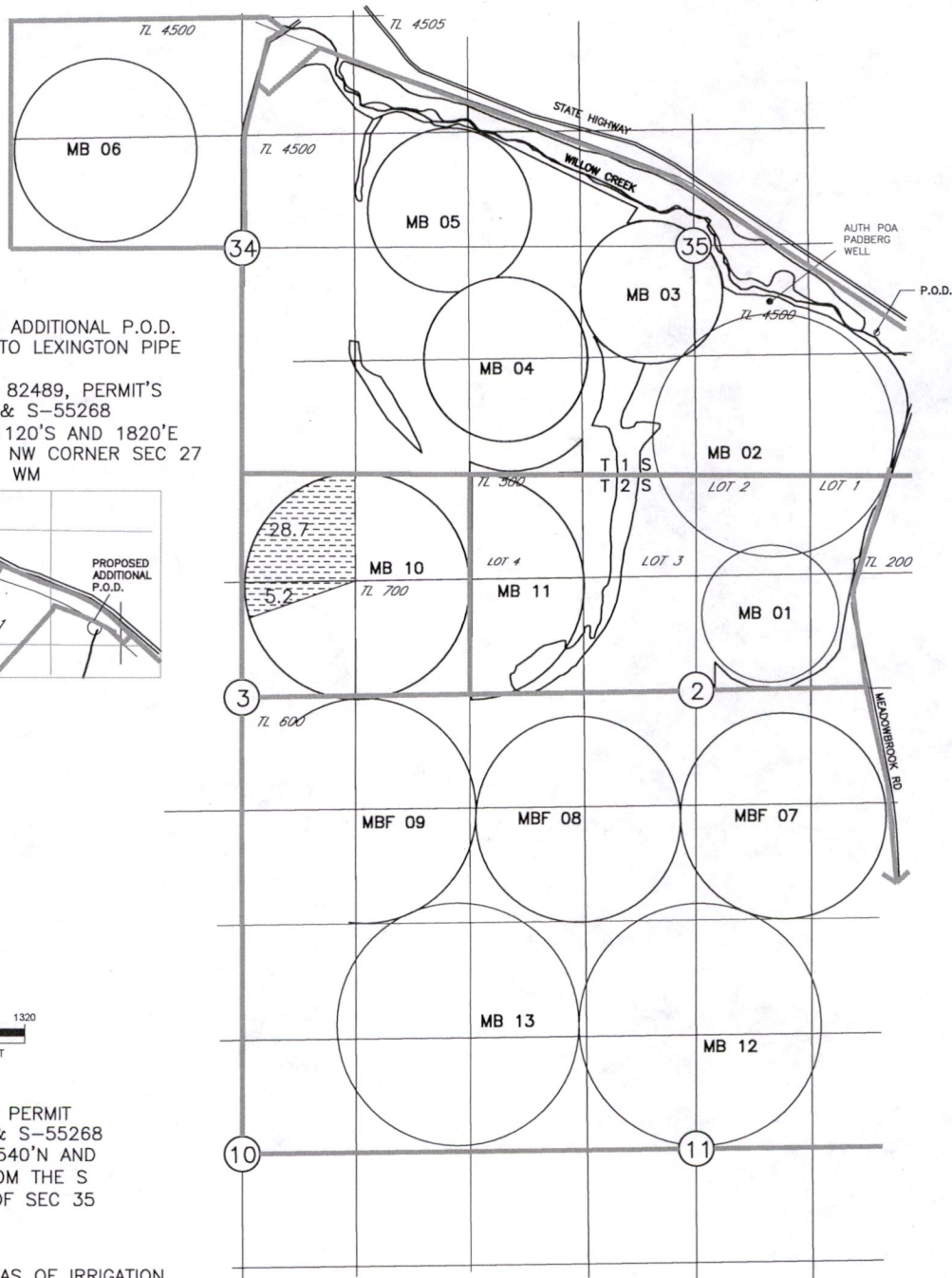

PROPOSED ADDITIONAL P.O.D.
 HEPPNER TO LEXINGTON PIPE
 LINE
 FOR CERT 82489, PERMIT'S
 S-54980 & S-55268
 LOCATED 1120'S AND 1820'E
 FROM THE NW CORNER SEC 27
 T2S R26E. WM

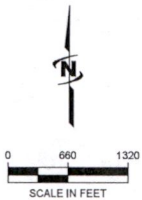
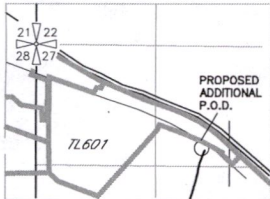

P.O.D. FOR PERMIT
 S-54980 & S-55268
 LOCATED 1540'N AND
 2100'E FROM THE S
 1/4 COR OF SEC 35

AREAS OF IRRIGATION

- 33.9 AC
 CERTIFICATE 30021 PRIMARY, PERMIT'S S-54980 &
 S-55268 SUPPLEMENTAL

NOTE:
 THE PURPOSE OF THIS MAP IS TO IDENTIFY THE APPROXIMATE LOCATION
 OF THE WATER RIGHT. IT IS NOT INTENDED TO PROVIDE INFORMATION
 RELATIVE TO THE LOCATION OF PROPERTY OWNERSHIP BOUNDARY LINES.

MEADOWBROOK C/O FRANK TIEGS
 2024 TEMPORARY TRANSFER APPLICATION MAP
 INVOLVING CERTIFICATES 94969
 AND PERMITS S-54980 & S-55268
 T1&T2S, R25E WM
 MORROW CO
 TO MAP (3 OF 6)

Received by OWRD

MAR 22 2024

Salem, OR

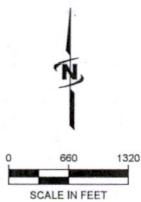

AUTHORIZED
 P.O.A. FOR CERT 94969
 LOCATED 1810'N AND
 1680'E FROM THE SE
 CORNER OF SEC 35

AREAS OF IRRIGATION
~~434.9~~
 435.5 AC PRIMARY
 CERTIFICATE 94969 PRIMARY, PERMIT'S
 S-54980 & S-55268 SUPPLEMENTAL

38.5 AC CERTIFICATE 94969 SUPPLEMENTAL

NOTE:
 THE PURPOSE OF THIS MAP IS TO IDENTIFY THE APPROXIMATE LOCATION
 OF THE WATER RIGHT. IT IS NOT INTENDED TO PROVIDE INFORMATION
 RELATIVE TO THE LOCATION OF PROPERTY OWNERSHIP BOUNDARY LINES.
 DRAWING: \\Kwkfiles\Public\Project\30-08-016 - Porifly Water Rights Consulting\00 Misc Engineering\Cod\TIEGS\30-08-016 24 ME TT.dwg
 PRINTED BY: kvaldovins on 02/05/24 12:38 PM

MEADOWBROOK C/O FRANK TIEGS
 2024 TEMPORARY TRANSFER APPLICATION MAP
 INVOLVING CERTIFICATES 94967
 AND PERMITS S-54980 & S-55268
 T1&T2S, R25E WM
 MORROW CO
 TO MAP (4 OF 6)

Received by OWRD

MAR 22 2024

Salem, OR

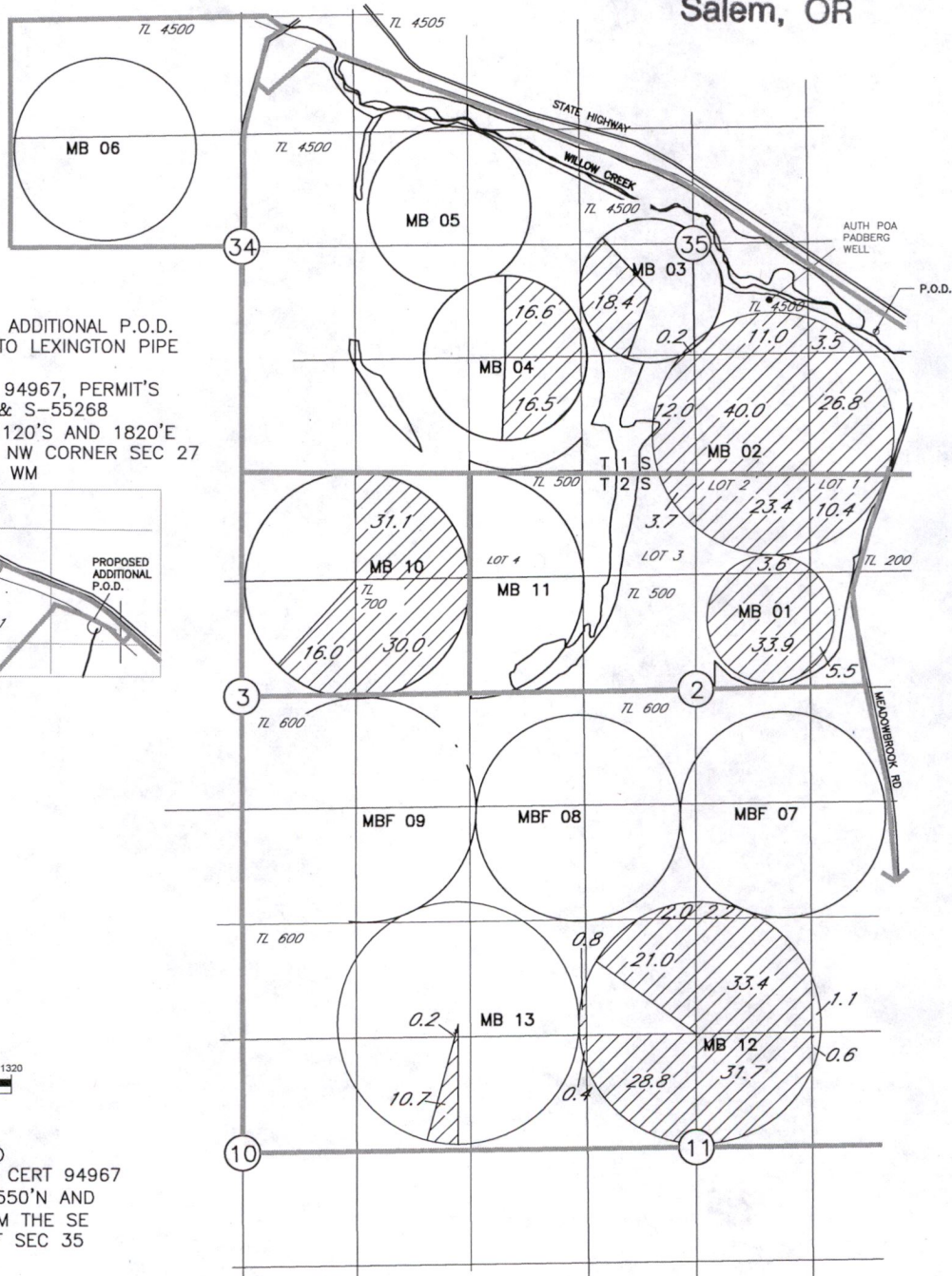

PROPOSED ADDITIONAL P.O.D.
 HEPPNER TO LEXINGTON PIPE
 LINE
 FOR CERT 94967, PERMIT'S
 S-54980 & S-55268
 LOCATED 1120'S AND 1820'E
 FROM THE NW CORNER SEC 27
 T2S R26E. WM

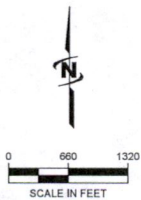
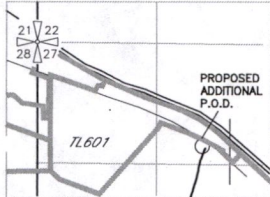

AUTHORIZED
 P.O.D. FOR CERT 94967
 LOCATED 1550'N AND
 640'W FROM THE SE
 CORNER OF SEC 35

AREAS OF SUPPLEMENTAL IRRIGATION



435.5 AC
 CERTIFICATE 94967 SUPPLEMENTAL & PERMIT'S S-54980 &
 S-55268 SUPPLEMENTAL

NOTE:
 THE PURPOSE OF THIS MAP IS TO IDENTIFY THE APPROXIMATE LOCATION
 OF THE WATER RIGHT. IT IS NOT INTENDED TO PROVIDE INFORMATION
 RELATIVE TO THE LOCATION OF PROPERTY OWNERSHIP BOUNDARY LINES.

DRAWING: \\Kwkfiles\Public\Project\30-08-016 - Porifly Water Rights Consulting\--00 Misc Engineering\Cad\TIEGS\30-08-016 24 ME TT.dwg
 PRINTED BY: kvoldovinos on 02/05/24 12:39 PM

MEADOWBROOK C/O FRANK TIEGS
 2024 TEMPORARY TRANSFER APPLICATION MAP
 INVOLVING CERTIFICATE 96377
 AND PERMITS S-54980 & S-55268
 T1&T2S, R25E WM
 MORROW CO
 TO MAP (5 OF 6)

Received by OWRD

MAR 22 2024

Salem, OR

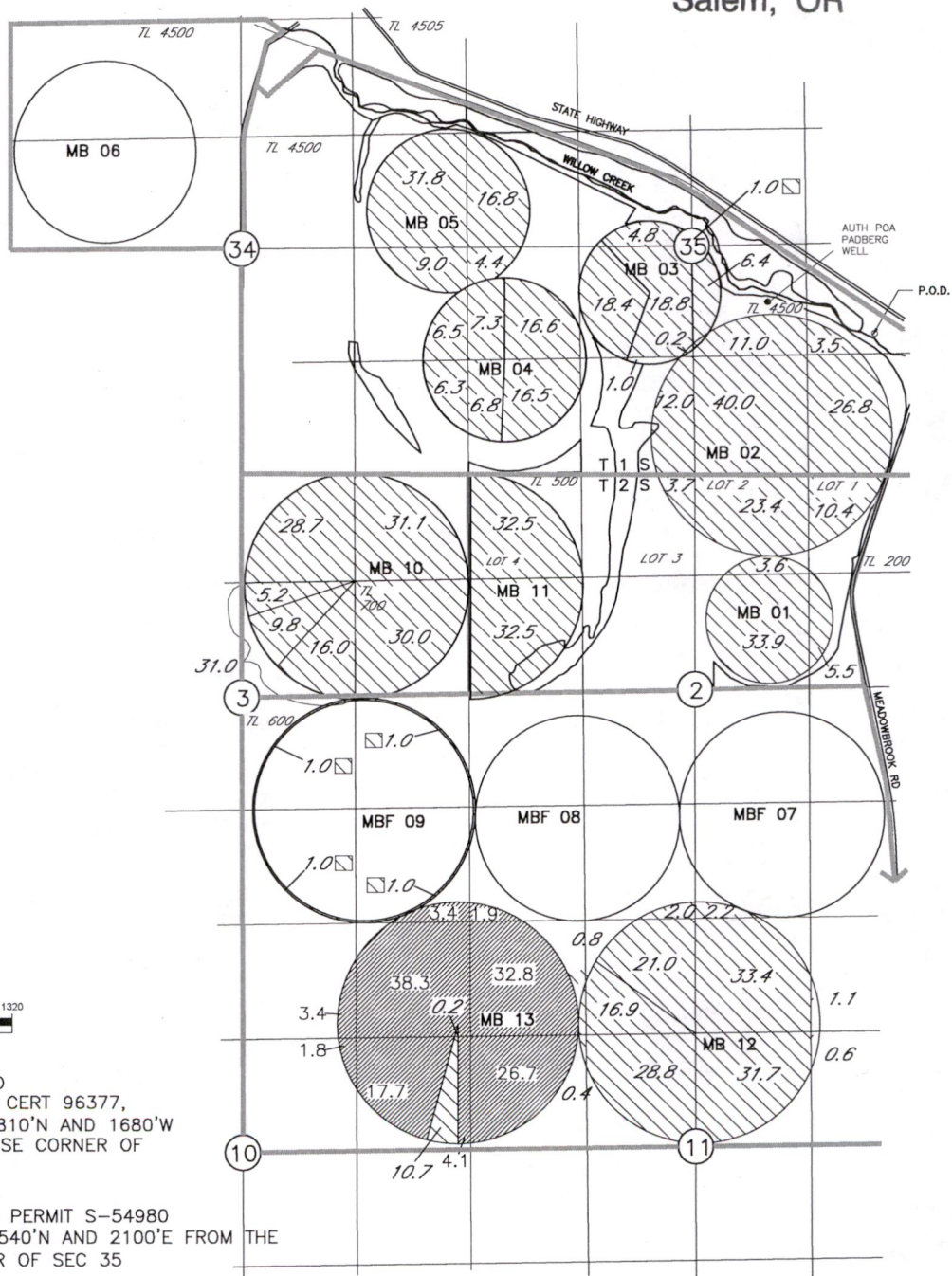

AUTHORIZED
 P.O.A. FOR CERT 96377,
 LOCATED 1810'N AND 1680'W
 FROM THE SE CORNER OF
 SEC 35

P.O.D. FOR PERMIT S-54980
 LOCATED 1540'N AND 2100'E FROM THE
 S 1/4 COR OF SEC 35

AREAS OF IRRIGATION
 130.1 AC CERTIFICATE 96377 PRIMARY,
 SUPPLEMENTAL S-54980 AND S-55268

 686.0 AC CERTIFICATE 96377
 SUPPLEMENTAL

NOTE:
 THE PURPOSE OF THIS MAP IS TO IDENTIFY THE APPROXIMATE LOCATION
 OF THE WATER RIGHT. IT IS NOT INTENDED TO PROVIDE INFORMATION
 RELATIVE TO THE LOCATION OF PROPERTY OWNERSHIP BOUNDARY LINES.
 DRAWING: \\wefiles\Public\Project\30-08-016 - Partly Water Rights Consulting\--00 Misc Engineering\Cod\TIEGS\30-08-016 24 ME TT.dwg
 PRINTED BY: kvoldovins on 02/05/24 12:39 PM

MEADOWBROOK C/O FRANK TIEGS
 2024 TEMPORARY TRANSFER APPLICATION MAP
 INVOLVING CERTIFICATE 94970
 AND PERMITS S-54980 & S-55268
 T1&T2S, R25E WM
 MORROW CO
 TO MAP (6 OF 6)

Received by OWRD

MAR 22 2024

Salem, OR

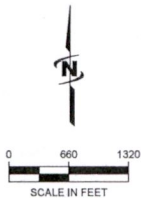
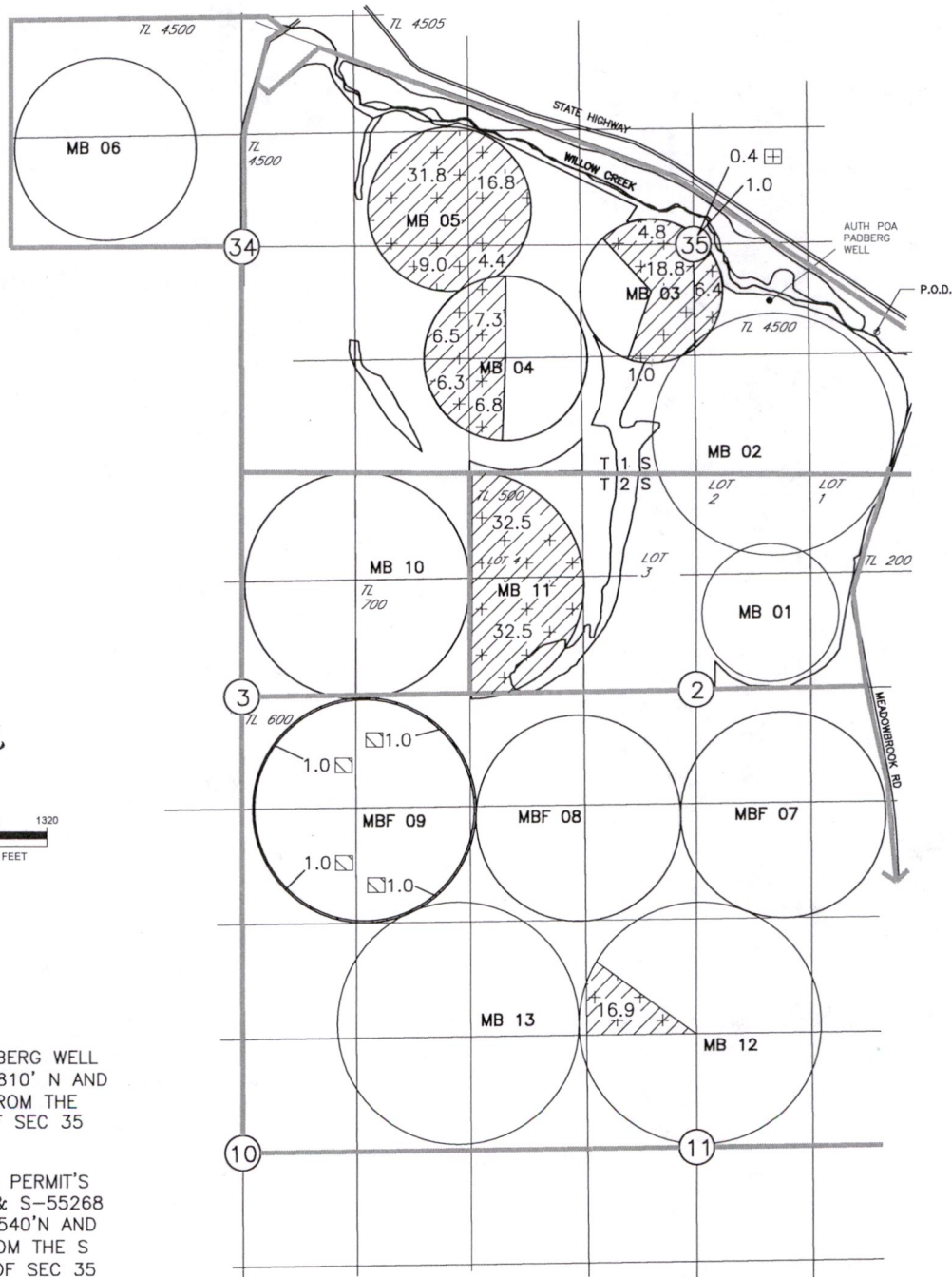

P.O.A. PADBERG WELL
 LOCATED 1810' N AND
 1680' W FROM THE
 SE COR OF SEC 35

P.O.D. FOR PERMIT'S
 S-54980 & S-55268
 LOCATED 1540' N AND
 2100' E FROM THE S
 1/4 COR OF SEC 35

AREAS OF IRRIGATION

206.8 AC
 CERTIFICATE 94970 PRIMARY

202.2 AC
 S-55268 SUPPLEMENTAL

NOTE:
 THE PURPOSE OF THIS MAP IS TO IDENTIFY THE APPROXIMATE LOCATION
 OF THE WATER RIGHT. IT IS NOT INTENDED TO PROVIDE INFORMATION
 RELATIVE TO THE LOCATION OF PROPERTY OWNERSHIP BOUNDARY LINES.

DRAWING: \\Kwkfiles\Public\Project\30-08-016 - Porifly Water Rights Consulting\--00 Misc Engineering\Cad\TIEGS\30-08-016 24 ME TT.dwg
 PRINTED BY: kvaldovinos on 02/05/24 12:39 PM